

1 Introduction	2
1.1 What is the FIRST® Robotics Competition (aka FRC)?	2
1.2 Gracious Professionalism™, A FIRST Credo	3
1.3 Prominent FRC Awards	4
1.3.1 The Chairman's Award	4
1.3.2 The Woodie Flowers Award	5
1.4 Safety: A FIRST Culture	5
1.5 Robot Design and Build Schedule	6
1.6 Rebound Rumble Summary	6
1.7 Revision History	7

Section

1

Introduction

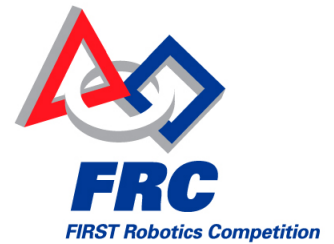

1 Introduction

1.1 What is the FIRST® Robotics Competition (aka FRC)?

Take dedicated, enthusiastic students, teachers, engineers and other professionals, add six weeks for design and fabrication and you get a wide range of amazing machines that are competition ready.

The *FIRST* Robotics Competition (FRC) is an exciting program that assimilates teams, sponsors, colleges and technical professionals with high school students to develop their solution to a prescribed engineering challenge in a competitive game environment. The competitions, combine the practical application of science and technology with the fun, intense energy and excitement of a championship-sporting event. The program results in life-changing, career molding experiences for its participants and is a lot of fun.

In 2012, FRC will reach nearly 55,000 students representing approximately 2,300 teams. FRC teams come from every state in the United States, as well as from Australia, Bosnia, Brazil, Canada, Chile, China, the Dominican Republic, Germany, Israel, Mexico, Spain, Taiwan, Turkey, and the United Kingdom. FRC has become an international program and is continuously growing. FRC teams will participate in 52 Regional Competitions, 9 Michigan District Events, the Michigan State Championship, 5 Mid-Atlantic Robotics District Events, and the MAR Region Championship. Approximately 300+ deserving teams will qualify to go to the *FIRST* Championship at The Edward Jones Dome in St. Louis, MO.

This year's challenge will be presented at the 2012 FRC Kickoff on Saturday, January 7, 2012. At the Kickoff event, all teams:

- see the 2012 game field for the first time;
- learn about the 2012 game rules and regulations; and
- receive a Kit of Parts (KOP). The KOP includes, but is certainly not limited to, motors, sensors, chassis hardware, transmissions, software packages, control systems and batteries. The intent of the kit is to provide a level starting point for all teams.

1.2 Gracious Professionalism™, A FIRST Credo

Dr. Woodie Flowers, *FIRST* National Advisor and co-founder of FRC, asks:

"Why do *FIRST* folks talk so much about that phrase?"

Dr. Flowers elaborates on the significance of Gracious Professionalism™ in *FIRST*, at work and in life, below.

"*FIRST* does not celebrate being an incompetent jerk. *FIRST* does celebrate high-quality, well-informed work done in a manner that leaves everyone feeling valued. Gracious Professionalism™ seems to be a good descriptor for a big part of the ethos of *FIRST*. It is one of the things that makes *FIRST* different and wonderful.

Gracious Professionalism™ has purposefully been left somewhat undefined because it can and should mean different things to each of us. We can, however, outline some of its possible meanings. Gracious attitudes and behaviors are win-win. Gracious folks respect others and let that respect show in their actions. Professionals possess special knowledge and are trusted by society to use that knowledge responsibly. Thus, gracious professionals make a valued contribution in a manner pleasing to others and to themselves.

In *FIRST*, one of the most straightforward interpretations of Gracious Professionalism™ is that we learn and compete like crazy, but treat one another with respect and kindness in the process. We try to avoid leaving anyone feeling like they have lost. No chest-thumping barbarian tough talk, but no sticky sweet platitudes either. Knowledge, pride and empathy comfortably blended.

Understanding that Gracious Professionalism™ works is NOT rocket science. It is, however, missing in too many activities. At *FIRST*, it is alive and well. Please help us take care of it.

In the long run, Gracious Professionalism™ is part of pursuing a meaningful life. If one becomes a professional, and uses knowledge in a gracious manner, everyone wins. One can add to society and enjoy the satisfaction of knowing that he or she has acted with integrity and sensitivity. That's good stuff!"

1.3 Prominent FRC Awards

FIRST recognizes both on-field and off-field team performance that promotes *FIRST*'s mission to change culture. Several awards celebrate team competencies including, but not limited to, technical expertise, community involvement, and safety practices. The two most prominent FRC awards are described below (however, for a complete list and description of awards available to teams, please reference [The FRC Administrative Manual, Section 6](#)).

1.3.1 The Chairman's Award

Every year, veteran FRC Teams have the opportunity to compete for *FIRST*'s most prestigious award; i.e., the Chairman's Award. This Award was created to maintain focus on changing culture in ways that would inspire greater levels of respect and honor for science and technology, as well as encourage more of today's youth to become scientists, engineers and technologists. It represents the spirit of *FIRST*. The Chairman's Award honors the team that best embodies the goals and purpose of *FIRST* and is a model for other teams to emulate.

Teams who have won the Chairman's Award at the Championship are entered into the *FIRST* Hall of Fame. Past Hall of Fame inductees are listed below.

Year	Team	Official Team Name
2011	359	NASA/Castle & Cooke, Inc. Dole Plantation/McInerney Foundation/University of Hawaii-Melvin Matsunaga/Randy Wood/Hawaii Space Grant Consortium/Ted's Bakery/AFCEA Hawaii/Waialua High School Foundation/Friends of Hawaii Robotics/North Shore Hanapa'a Club/BAE Systems/Waialua Federal Credit Union/Waialua Lions Club/Hawaiian Dredging/University of Hawaii-College of Engineering/Iron Horse Development/Dole Food Company of Hawaii/Hawaii Visitors and Convention Bureau/Aloha Gourmet Products/GT Pies/Islander Group/KTM Services Inc./Maui Divers of Hawaii/Pioneer Hi-Bred International/Gone Tropo, LLC/Kai Media & Marketing/Coca Cola Hawaii/Learning Train LLC/Oils of Aloha/The Duck Company/GAK Enterprises/H&W Foods/Sharpshooter Spectrum Venture/Sunset International/Pacific Jobbers Warehouse/Gordon Kuwada/CMKLV/Charles Nakoa III/Hawaii State Federal Credit Union/Kenneth Koga & Waialua High School & HI DOE
2010	341	DOW Chemical/Lockheed Martin/Cobham Defense Electronics/Comcast Cable/BAE Systems/Centocor Ortho BioTech/Johnson & Johnson PRD/JCPenney/PJM Interconnection/DeVry University & Wissahickon High School & North Montco Technical Career Center
2009	236	Dominion Millstone Power Station & Lyme-Old Lyme (CT) High School
2008	842	Honeywell / Arthur M. Blank Foundation / Science Foundation Arizona / Intel / Vegas Fuel / Wells-Fargo & Carl Hayden High School
2007	365	DuPont Engineering/DuPont CCRE/First State Robotics & MOE Robotics Group
2006	111	Motorola & Rolling Meadows High School & Wheeling High School
2005	67	General Motors Milford Proving Ground and Huron Valley Schools
2004	254	NASA Ames Research Center/Laron Incorporated/Unity Care Group/Line-X of San Jose/PK Selective Metal Plating, Inc. & Bellerme College Preparatory
2003	103	NASA/Amplifier Research/Custom Finishers/Lutron Electronics/BAE Systems & Palisades High School
2002	175	Hamilton Sundstrand Space Systems International/The New England Air Museum/Techni-Products/Veritech Media & Enrico Fermi High School

Year	Team	Official Team Name
2001	22	NASAJPL/Boeing/Rocketdyne/FADL Engineering/Decker Machine & Chatsworth High School
2000	16	Baxter Healthcare Corporation & Mountain Home High School
1999	120	NASA Lewis Research Center/TRW, Inc./Battelle Memorial Institute & East Technical High School
1998	23	Boston Edison & Plymouth North High School
1997	47	Delphi Corporation & Pontiac Central High School
1996	144	Procter & Gamble & Walnut Hills High School
1995	151	Lockheed Sanders & Nashua High School
1994	191	Xerox Corporation & JC Wilson Magnet High School
1993	7	AT&T Bell Labs & Science High School
1992	191	Xerox Corporation & JC Wilson Magnet High School

1.3.2 The Woodie Flowers Award

The Woodie Flowers Award celebrates mentors who lead, inspire and empower their team. Woodie Flowers Award winners demonstrate effective communication in the art and science of engineering and design. Founded in 1996 by Dr. William Murphy, the Woodie Flowers Award is presented to an outstanding engineer or teacher participating in FRC who lead, inspire, and empower using excellent communication skills.

Students submit an essay that nominates one mentor from their team for consideration. Past winners of this award are listed below.

Year	Name	Title
2011	Mr. John Larock	Staffing Manager, Dupont
2010	Mr. Chris Fultz	Program Director - RR500 and New Product Introduction, Defense Sector, Rolls Royce
2009	Mr. John Novak	Engineer, Baxter Healthcare Corporation
2008	Mr. Mark Breadner	Vice Principal, Toronto District School Board
2007	Mr. Dan Green	Director, New Technology Business Operations, Motorola
2006	Mr. Rob Mainieri	Teacher, The Preuss School at UCSD
2005	Mr. Paul Copioli	Staff Engineer, FANUC Robotics America
2004	Mr. David Kelso	Teacher, Central High School
2003	Mr. Andy Baker	President, AndyMark, Inc.
2002	Mr. David Verbrugge	Engineer, GM Proving Ground
2001	Mr. William Beatty	Beatty Machine & Manufacturing Company
2000	Ms. Kyle Hughes	Teacher, OSMTech Academy
1999	Mr. Ken Patton	Engineer, GM Powertrain
1998	Mr. Michael Bastoni	Teacher, Plymouth North High School
1997	Ms. Elizabeth Calef	Teacher, Bridgewater-Raynham Regional High School

1.4 Safety: A FIRST Culture

Safety is critical within *FIRST* and must be observed continuously by all participants. As a part of the Safety Awareness and Recognition Program, teams are observed and evaluated at many different levels and by many individuals at the event.

“Safety Advisors” evaluate team safety behavior and practices at Regional Competitions.

“Referees” observe safety on the playing field as well as adherence to the game rules.

“Judges” evaluate how teams have integrated safety into their robot designs when considering the team for technical awards.

Safe practices at the competitions are required. Teams are urged to adopt safe habits throughout the entire competition season including during travel to and from events and while working in their shops at home.

1.5 Robot Design and Build Schedule

One of the purposes of the FRC is to provide team members with the experience of conceiving, designing, and constructing their solution to the annual competition challenge. We want each student to have the experience of creating a new system each year. As the team considers the creation of their machine, this aspect of the program should be kept in mind. Solutions that merely bolt together a minimum number of externally-designed COTS subsystems may not offer the students the opportunity to understand the “why” or “how” of an item’s design. Likewise, solutions that are merely minor modifications of a design utilized for a previous competition does not offer the current students complete insight into the full design process. Purchasing optimization and design re-use are both important concepts, however teams must be cautious not to over-utilize them to the point that the student’s experience is compromised.

This intent is clearly met when a team obtains a Mechanism or COTS items that was designed for non-*FIRST* purposes, and then modifies or alters it to provide functionality for the Robot. For example, if a team obtains a gearbox from a power drill and modifies it to use on the Robot, they gain insight into the design of the original gearbox purpose, learn to characterize the performance of the original design, and implement the engineering design process to create their customized application for the gearbox.

However, COTS items that have been specifically designed as a solution to part of the FRC challenge may or may not fit within the FRC intent, and must be carefully considered. If the item provides general functionality that can be utilized in any of several possible configurations or applications, then it is acceptable (as the teams will still have to design their particular application of the item). However, COTS items that provide a complete solution for a major Robot function (e.g. a complete manipulator assembly, pre-built pneumatics circuit, or full mobility system) that require no effort other than just bolting it on to the Robot are against the intent of the competition, and will not be permitted.

1.6 Rebound Rumble Summary

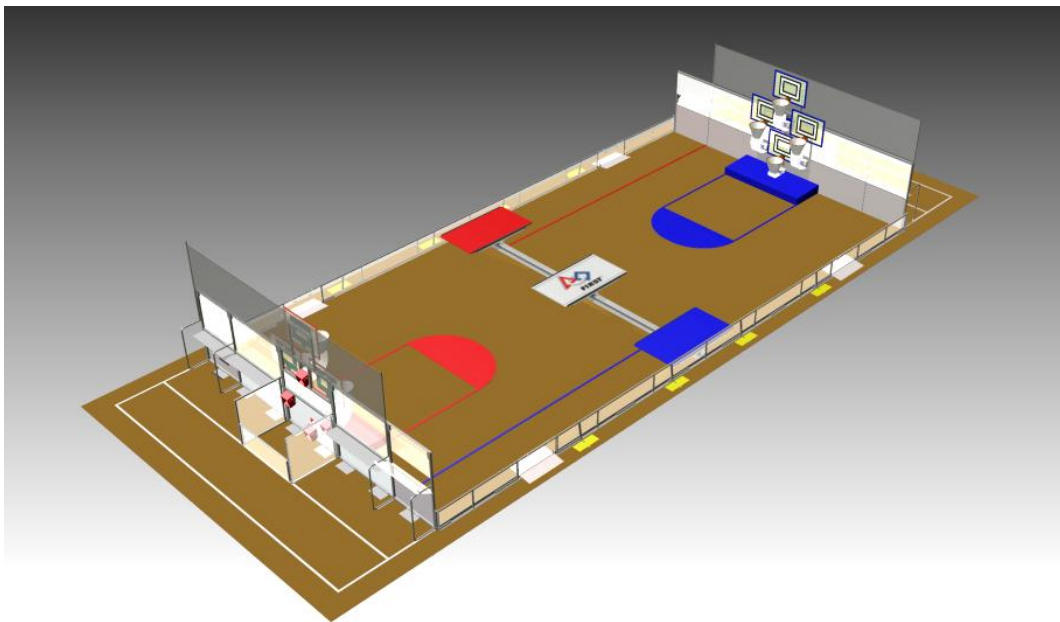

Rebound Rumble is played by two competing alliances on a flat, 27 x 54 ft field. Each alliance consists of three robots. They compete to score as many basketballs into their hoops as they can during a 2 minute and 15 second match. The higher the hoop in which the basketball is scored, the more points the alliance receives.

The match begins with a 15-second Hybrid Period in which robots operate independently of driver inputs. During this Hybrid Period, one robot on each alliance may be controlled using a Microsoft Kinect. Baskets scored during this period are worth extra points. For the remainder of the match, drivers control robots and try to maximize their alliance score by scoring as many baskets as possible.

The match ends with robots attempting to balance on bridges located at the middle of the field. In Qualification Matches, a robot from each alliance will also try to balance on the white Coopertition™ bridge to score additional ranking points for each alliance. Scoring for the match is summarized below.

Hoop	Hybrid Points	Teleop Points
Top	6	3
Middle	5	2
Bottom	4	1

# of Robots on Bridge	Qualification Points	Elimination Points
1	10	10
2	20	20
3	20	40

1.7 Revision History

Revision	Release Date	Changes
-	1/3/12	Initial Release

2 The Arena	2
2.1 Overview	2
2.2 The Arena	3
2.2.1 The Court	3
2.2.2 Court Markings	4
2.2.3 The Players	5
2.2.4 The Hoops	5
2.2.5 The Bridges	6
2.2.6 The Alliance Stations	7
2.2.7 The Inbound Stations	7
2.2.8 The Corral	8
2.2.9 The Player Stations	8
2.2.10 The Kinect Stations	8
2.2.11 The Basketballs	9
2.3 Revision History	9

Section 2

The Arena

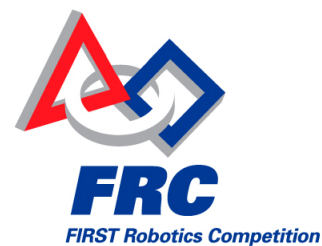

2 The Arena

2.1 Overview

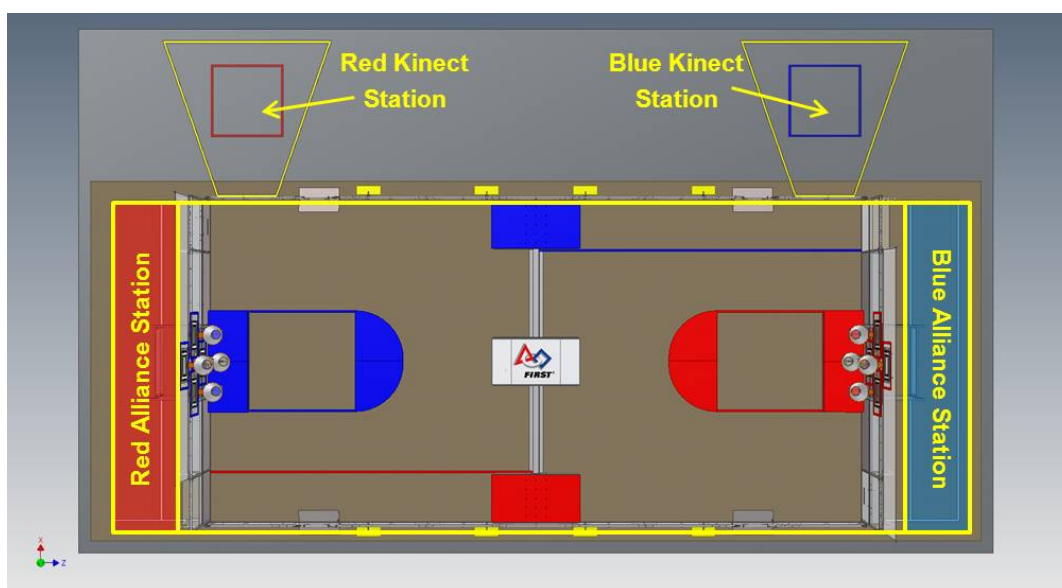

Note: These illustrations are for a general visual understanding of the Rebound Rumble Arena only. Please refer to the official drawings for exact dimensions and construction details.

The Arena includes all elements of the game infrastructure that are required to play *Rebound Rumble*: the Court, the Alliance Stations, Kinect Stations and all supporting communications, arena control, and scorekeeping equipment.

Robots play *Rebound Rumble* on a rectangular field known as the Court. During the Matches, the Robots are controlled from Alliance Stations located outside the ends of the Court. These rectangular zones consist of three Player Stations that provide connectivity between the controls used by the Drivers and the Arena. Hoops are attached to the surface of the Alliance Walls facing the Court.

The drawings and CAD models for the *Rebound Rumble* Arena used in competition can be found on the *FIRST* web site [here](#) (dimensions stated in this document are approximate). Note that the web site also contains drawings for low-cost versions of the important elements of the Arena. Teams may choose to build these versions for their own use during the construction and testing of the Robot. These drawings can be found [here](#). Links to CAD models, hosted by Autodesk and PTC, can be found [here](#).

The competition Arenas are modular constructions that are assembled, used, disassembled, and shipped many times during the competition season. They may undergo wear and tear. The Arena is designed to withstand rigorous play and frequent shipping, and every effort is made to ensure that the Arenas are as identical from event to event as possible. However, as the Arenas are assembled in different venues by different event staff, some small variations do occur. Fit and tolerance on large assemblies (e.g. the Bridge) are ensured only to within $\frac{1}{4}$ in. Overall gross dimensions of the entire Court may vary up to 4 in. Successful teams will design Robots that are insensitive to these variations.

2.2 The Arena

Note: The official Rebound Rumble Arena description, layout, dimensions and parts list are contained in the "FE-00035 - 2012 Arena Layout and Marking" Drawing. Diagrams and dimensions below are for illustrative purposes only.

2.2.1 The Court

The Court for *Rebound Rumble* is a 27 by 54 ft carpeted area, bounded by two Alliance Walls and a guardrail system. The Court is covered with carpet (Shaw Floors, Philadelphia Commercial, Neyland II, 20, 30753, "park bench"). Hoops are located at the ends of the Court attached to the Alliance Walls. Three Bridges are located in the center of the Court. Areas of red and blue tape on the surface of the Court denote Alleys; solid red and blue semicircular areas are Keys.

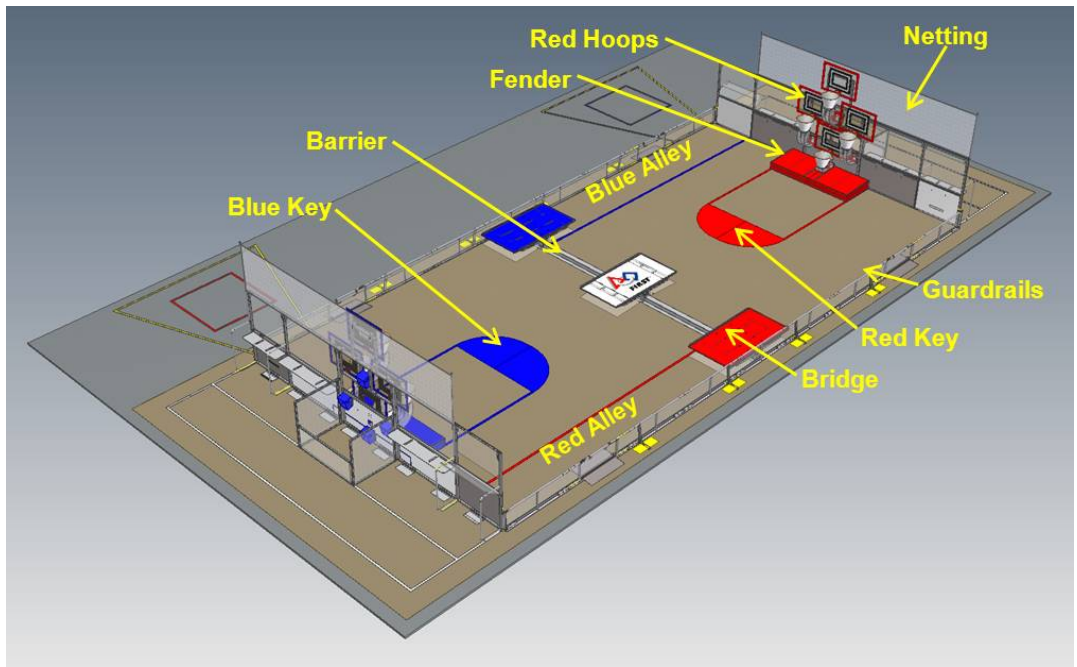

The Alliance Walls are 6 ½ ft high, 27 ft wide, and define the ends of the Court. The Alliance Wall protects the Player Stations, and is composed of a 3 ft high base of diamond plate aluminum topped with a 3 ½ ft high transparent polycarbonate panel.

The guardrail system is a horizontal pipe 20 in. above the floor, supported by vertical struts mounted on a 3 in. aluminum angle. A shield is attached on the inside of the guardrail system, extending from the floor to the top of the guardrail, and running the length of the guardrail. The shield is intended to help prevent Robots, in whole or in part, from inadvertently exiting the Court during a Match. The Guardrail System defines the borders of the Court, except where it is bounded by the Alliance Wall.

Four gates in the guardrail system allow easy access to the Court for placement and removal of Robots. The gates are 38 in. wide, and are closed and shielded during Matches.

2.2.2 Court Markings

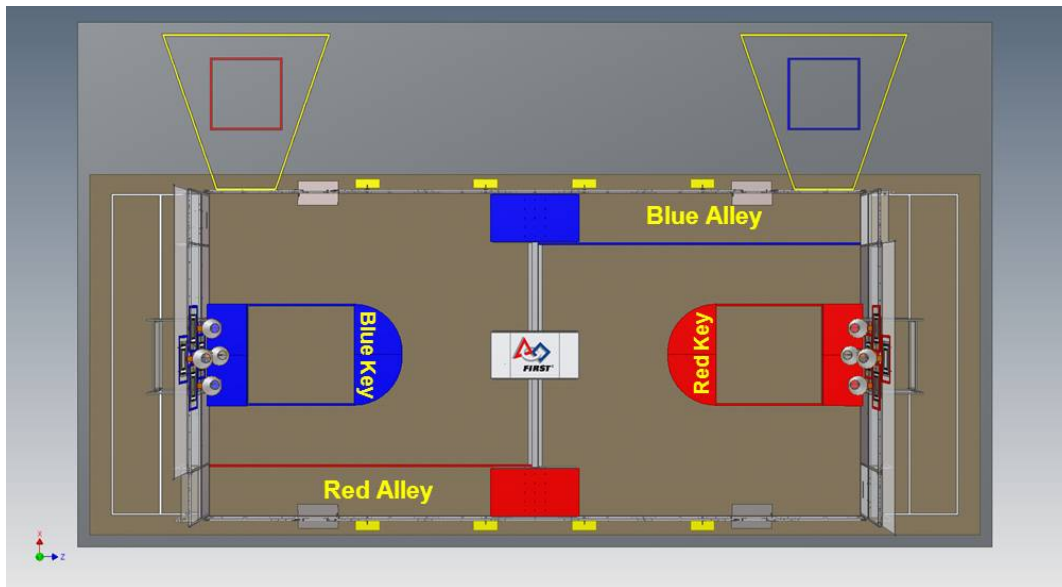

(For illustrative purposes only - please refer to Drawing FE-00035 for exact dimensions)

There is one Key for each Alliance, located in front of their opponent's Alliance Wall. The Key is an elongated semicircle that is 101 in. wide and 48 in. deep. The flat edge of the Key is located 144 in. from the Alliance Wall and centered on the width of the Court. The Key is made of 1/8 in. thick red or blue HDPE plastic attached to the carpet via Velcro.

Each Alliance has one Alley that extends along the side of the Court from their Inbound Station to their Bridge. Each Alley is approximately 51 in. wide and is adjacent to the edge of the Court, and is marked by 2 in. wide gaffers tape (Pro Gaff Tape, "electric blue" and "red", 2 in.); the tape is part of the Alley.

The red and blue tape running from the Keys to the Fenders are purely decorative and have no other function in *Rebound Rumble*.

2.2.3 The Players

Each FRC team may provide up to four Players for each Match: two Drivers, one Inbounder, and one Coach. The Drivers must be pre-college student team members and are responsible for operating and controlling the Robot. The Inbounders must be pre-college student team members and are responsible for entering Basketballs onto the Court. The Coach may be a student or adult team member. The Coach must wear the designated "Coach" pin or button during the Match.

2.2.4 The Hoops

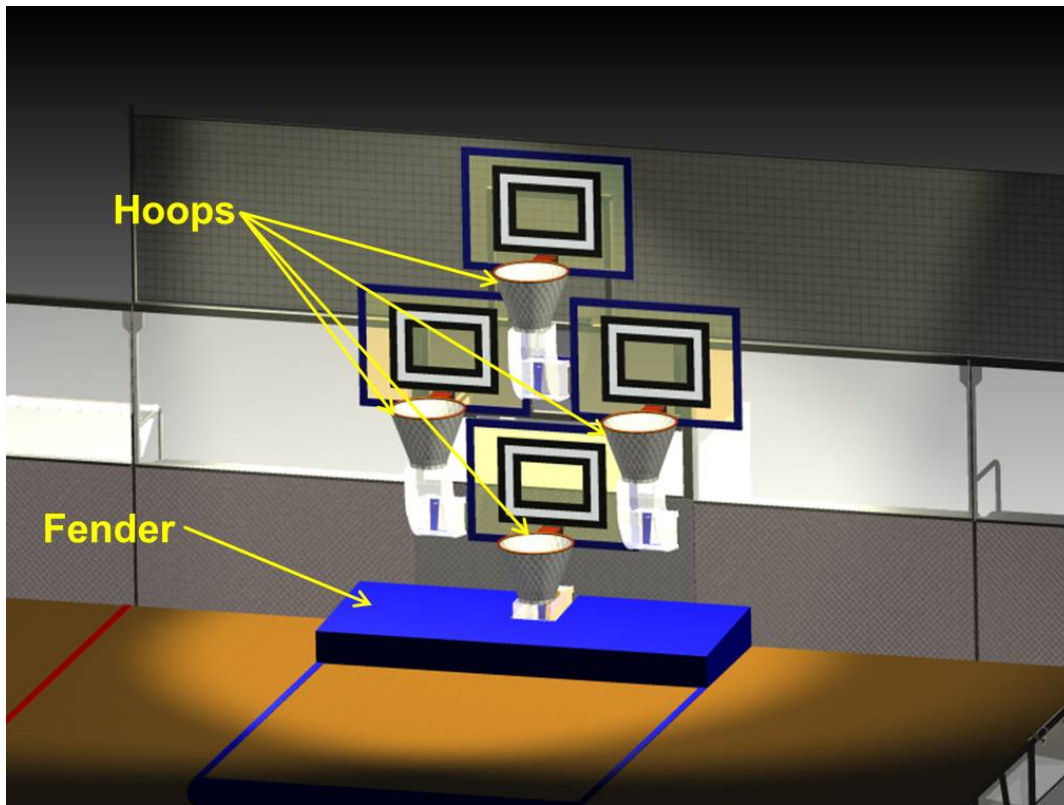

The Hoops (Huffy Spalding “Slam Jam” Red Replacement Basketball Rim, model #7800s; Lifetime Basketball Net 120gram, model #0790; McMaster #9573K68 used instead of stock spring) are used to receive Basketballs that are scored by the Robots as they play *Rebound Rumble*. Four Hoops are attached to the inside face of each Alliance Wall. There is one bottom Hoop, two middle Hoops, and one top Hoop. The bottom and top Hoops are centered on the Alliance wall while the middle Hoops are centered 27-3/8 in. to either side of the center of the Alliance Wall. When measured from the carpet to the top edge of a rim, the bottom, middle, and top Hoops are 28 in., 61 in., and 98 in. high off the floor, respectively. The rim of a Hoop has an inner diameter of 18 in. The closest point on the inside edge of a rim is 6 in. away from the face of a backboard. The backboard on each Hoop is 44 by 31-1/2 in. and made of smoked 1/2 in. thick polycarbonate. Backboards are outlined in a 2 in. thick blue or red stripe.

A retro-reflective Vision Target (Reflexite GP020, 50mm; Pro Gaff Tape, “black”, 2 in.) is mounted behind each Hoop. The Vision Target is a rectangle with an outer width of 24 in., an outer height of 18 in., and a stroke of 2 in. The Vision Target is centered on the backboard with a distance of 2 in. from the lowest edge of retro-reflective material to the upper edge of the rim. There is a 2 in. stroke strip of black gaffers tape on both the inside and outside of the retro-reflective rectangle.

A Fender is located directly below the Hoops at each end of the Court. The Fender is designed to protect the Hoops from damage by Robots. The Fender is 38-3/4 in. deep by 101 in. wide and measures 8-1/4 in. tall at the front, and 10-1/4 in. tall at the back against the Alliance Wall.

2.2.5 The Bridges

Robots traverse the center of the Court by crossing over either one of three Bridges or the 4 in. tall by 6 in. wide, smooth steel Barriers running between them. Each Alliance has one dedicated Bridge for their use at end of their Alley. An additional white Coopertition Bridge is located at the center of the Court. Each Bridge is 48 in. wide, 88

in. long (outside dimensions), and sits with the top platform 12 in. high off the ground when level. Each Bridge is mounted on a double-hinge that allows the Bridge to tip towards either end of Court.

A Bridge will count as Balanced if it is within 5° of horizontal.

2.2.6 The Alliance Stations

The Alliance Stations are located at either end of the Arena, behind the Alliance Walls. The Players remain in their assigned Alliance Station during the Match.

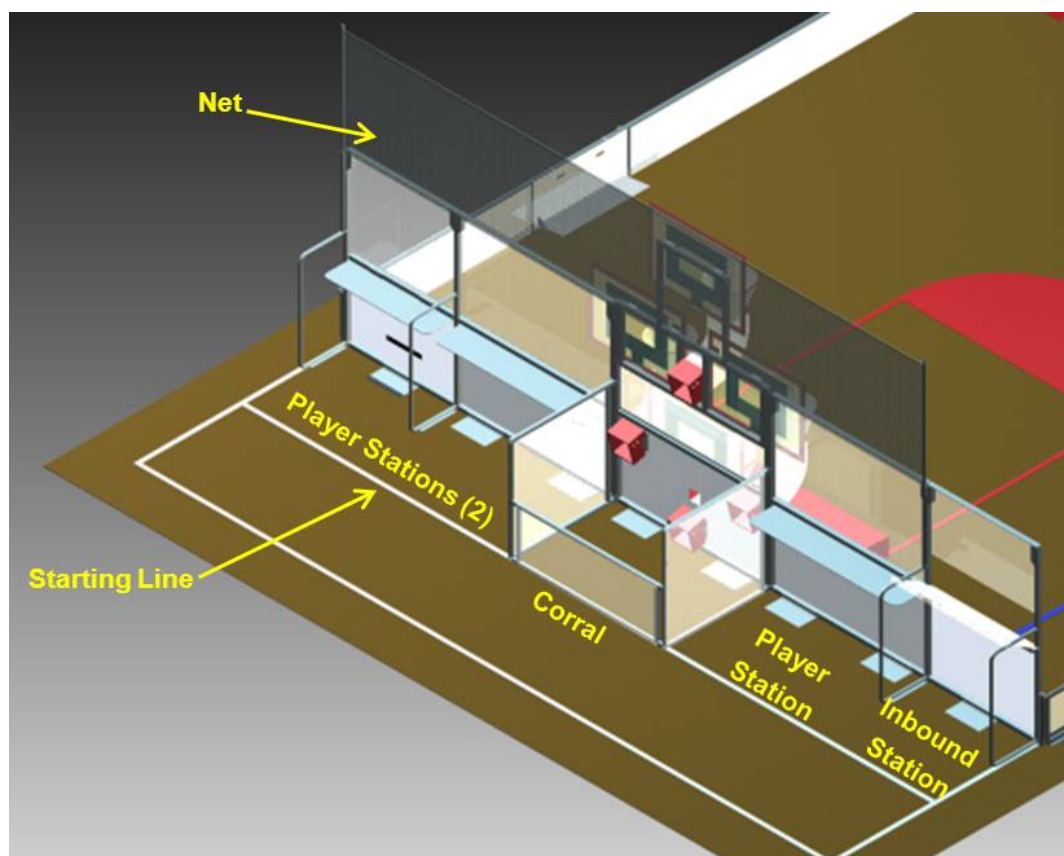

The Alliance Station extends back 8 ft from the Alliance Wall, and spans the entire width of the wall. The Alliance Station includes the three Player Stations and one Inbound Station. The Starting Line is marked on the floor 4 ft back from the Alliance Wall, and extends across the width of the Alliance Station. The Alliance Station includes the area behind the Starting Line. All boundaries for the Alliance Stations are marked on the carpet with white tape (Pro Gaff Tape, "white", 2 in.). The tape boundaries are considered part of the bounded areas.

Netting is located above each Alliance Wall to help keep Basketballs in the Court. This netting extends the full width of the Alliance Station, except for the Inbound Station.

2.2.7 The Inbound Stations

An Inbound Station is located on the side of the Alliance Station at the end of the Alley. The Inbound Station is approximately 4 ft 3 in. wide. There is no netting above the Inbound Station.

The Inbound Slots are openings in the Alliance Wall that can be used by the Inbounders to enter Basketballs onto the Court. One Inbound Slot is located in each Inbound Station. Each Inbound Slot is approximately 13 in. tall, and spans the width of the Inbound Station. The lowest edge of the slot is located 37 in. above the floor of the Court. Extending back from the Inbound Slot into the Inbound Station is a chute comprised of a sloped piece of polycarbonate. The chute spans the width of the Inbound Slot, and is sloped at an angle of 34° above horizontal

2.2.8 The Corral

In the center of the Alliance Station is the Corral. Basketballs scored in Hoops feed through the scoring counters and into this enclosed area. The interior dimensions of the Corral are 6 ft wide by 4 ft long. The Corral has 4 ft tall side walls, and a 2 ft tall front containment wall.

2.2.9 The Player Stations

One Player Station is located between the Inbound Station and Corral. The remaining two Player Stations are located on the opposite side of the Corral. The Player Station on the end of the Alliance Wall is 51 in. wide, while the other two Player Stations are 72 in. wide. All three Player Stations have the components detailed below.

Attached to the Alliance Wall in each Player Station is an aluminum shelf to support the Operator Consoles for the FRC team in that Player Station. The support shelf measures at least 48 in. wide by 12 in. deep. There is a 3 ft long by 2 in. wide strip of Velcro tape ("loop" side) along the center of the support shelf that may be used to secure the Operator Consoles to the shelf. Each setup location includes a competition cable (to provide Ethernet connectivity) that attaches to the Ethernet Port of the Operator Console. The cable provides communications with the Robot.

Each Player Station also includes a power adaptor cable that may be used to power the Classmate laptops that were provided to teams in the Kit of Parts starting in 2010. Emergency Stop (E-Stop) buttons for each Robot are located on the left side of each Player Station shelf. Arena components (including team number displays, competition arena hardware, alliance lights, control hardware cabinets and clock displays) are also located above the Player Stations and below the shelf.

2.2.10 The Kinect Stations

Two Kinect Stations are located outside the Court. Each Kinect Station extends 8 ft from the Alliance Wall towards the center of the Court, and extends 10 ft back from the guardrail. At most competitions, both Kinect Stations will be located on the same side of the Arena as the scoring table. At some venues however, one Kinect Station may

be located on the side of the Arena opposite the scoring table.

Each Kinect Station has a Microsoft Kinect mounted to shelf that is approximately 44 in. off the floor. A feedback monitor is located on a separate shelf directly below the Microsoft Kinect. The Microsoft Kinect is centered along the 8 in. side of the Kinect Station that is closest to the Court.

2.2.11 The Basketballs

While playing *Rebound Rumble*, Robots manipulate Basketballs to accomplish the objectives of the game. The Basketball is a Size 4 Compact foam basketball (Gopher Delusious™ Foam Basketball, Item # 71-502) with an outer circumference of 25 in. and approximate weight of 11.2 oz.



2.3 Revision History

Revision	Release Date	Changes
-	1/3/12	Initial Release

3 The Game	3
3.1 Gameplay Rules	3
3.1.1 Pre-Match	3
[G01]	3
[G02]	3
[G03]	4
[G04]	4
[G05]	4
3.1.2 General Rules	4
[G06]	4
[G07]	4
[G08]	5
[G09]	5
[G10]	5
[G11]	5
[G12]	5
[G13]	6
[G14]	6
[G15]	6
3.1.3 Hybrid Rules	6
[G16]	6
[G17]	6
[G18]	7
[G19]	7
3.1.4 Robot Actions	7
[G20]	7
[G21]	7
[G22]	7
[G23]	8
[G24]	8
[G25]	8
3.1.5 Robot-Robot Interaction	8
[G26]	9
[G27]	9
[G28]	9
[G29]	10
[G30]	10
3.1.6 Human Actions	11
[G31]	11
[G32]	11

[G33]	11
[G34]	11
[G35]	11
[G36]	12
3.2 Scoring	12
[G37]	12
[G38]	12
[G39]	12
[G40]	12
[G41]	13
3.3 Fouls	13
[G42]	13
[G43]	13
[G44]	13
[G45]	13
3.4 Revision History	14

Section
3

The Game

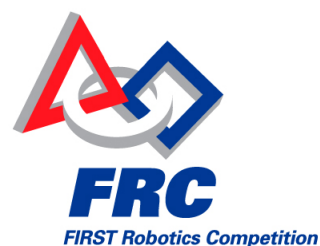

3 The Game

3.1 Gameplay Rules

3.1.1 Pre-Match

[G01]

When placed on the Court, each Robot must be in compliance with all Robot rules, may not exceed 60 in. tall, and have all appendages within its Frame Perimeter. The Robot must be in contact with its Key, and may contain up to two Basketballs.

Violation: Disabled for the Match and re-Inspection if an illegal Robot

[G02]

Alignment devices such as templates, tape measures, laser pointers, etc. that are not part of the Robot and fully contained within the starting volume may not be used to assist with positioning the Robot.

Violation: Robot will be arbitrarily repositioned by a Referee prior to the start of the Match.

[G03]

Items other than Robots and Basketballs shall not be placed on the Court prior to or during the Match.
Violation: Match will not start until the situation is corrected.

[G04]

Each FRC team provides up to four Players (a Coach, two Drivers and an Inbounder). Prior to Match start, each Player must be in their Alliance Station and behind their Starting Line, except Alliances may elect to have an Inbounder in the Kinect Station during Hybrid. The Coach must wear the designated "Coach" pin or button during the Match.

Violation: Match will not start until the situation is corrected.

[G05]

Each Bridge will be preset with two Basketballs. Basketballs allotted to Robots that are not used, will be preset on the Coopertition Bridge.

Violation: Match will not start until the situation is corrected.

3.1.2 General Rules

[G06]

A Match is 2 minutes and 15 seconds long. The Hybrid period (Hybrid) is the first 15 seconds of the Match. The Teleoperated period (Teleop) is the remaining 2-minute period. Each period ends when the Arena timer displays zero seconds.

During Hybrid, the Bridges will be illuminated in yellow. At the end of the Match, they will be illuminated with the matching color if the Bridge is Balanced and has one or more Robot(s) on it. When it is safe to enter the field after the Match, the Bridges will be illuminated green.

[G07]

If at any time a Robot's operation or design is deemed unsafe, the Robot will be disabled for the remainder of the Match. If the safety violation is due to the Robot design, the Head Referee has the option to not allow the Robot back onto the Court until the design has been corrected.

Violation: Foul and disablement

An example of unsafe operation would be uncontrolled motion that cannot be stopped by the Drivers.

[G08]

Robots may not touch anything outside the Court boundary.

Violation: Disablement; however if it occurs during Hybrid, and there is no safety concern, the Head Referee will allow a 10-second grace period at the beginning of Teleop for the Robot to return to the Court.

[G09]

Robots may not intentionally detach parts or leave mechanisms on the Court.

Violation: Foul

[G10]

Robots may not grab, grasp, grapple, or attach to any Arena structure. (Robots may push or react against any elements of the Arena that is not protected by another rule.)

Violation: Foul

[G11]

Robots may not become entangled in the Arena elements.

Violation: May be disabled and will not be freed until after the Match has finished.

[G12]

Robots may not damage any part of the Arena, including Basketballs.

Violation: Potential Disablement if the Head Referee determines that further damage is likely to occur. Corrective

action (such as eliminating sharp edges, removing the damaging mechanism, and/or re-Inspection) may be required before the Robot will be allowed to compete in subsequent Matches.

Basketballs are expected to undergo a reasonable amount of wear and tear as they are handled by Robots, such as scratches and occasional marks. Robots that gouge, tear off pieces, or routinely mark Basketballs will be charged with Arena damage and will be required to rectify the situation.

[G13]

Basketballs may not be intentionally placed out of bounds. Basketballs that inadvertently exit the Court will be placed back on the Court approximately at the point of exit, at the earliest safe opportunity, by Court staff.

Violation: Foul

[G14]

Strategies that use Basketballs to either aid or inhibit balancing of any Bridge are not allowed.

Violation: Technical-Foul, and counting or discounting the affected Bridge as balanced, as appropriate.

[G15]

While in the Arena, including before and after a Match, Players must be civil towards other Players, competition personnel, and event attendees.

Violation: Potential Red Card if during a Match. Teams will not receive fouls for off-Arena actions; however designated competition personnel will hold them accountable for their off-Arena actions.

3.1.3 Hybrid Rules

[G16]

During Hybrid, Robots may not contact the carpet on their Alliance Station end of the Court.

Violation: Foul

[G17]

During Hybrid, Players must remain in their assigned starting positions.

Violation: Foul

[G18]

During Hybrid, Players may not touch Basketballs.

Violation: Foul

[G19]

During Hybrid, any control devices worn or held by the Drivers must be disconnected from the Operator Console, and not connected until Teleop.

Violation: Foul

3.1.4 Robot Actions

[G20]

Robots in contact with the carpet on their Alliance Station end of the Court are limited to 60 in tall. Otherwise, Robots are limited to 84 in tall.

Violation: Foul; or Technical-Foul for repeated or continuous violation.

[G21]

Robots may extend one appendage up to 14 in. beyond a single edge of their frame perimeter at any time.

Violation: Foul for exceeding size allotments; Technical-Foul for continuous or repeated violations.

These appendages are intended for use in manipulating Basketballs and/or Bridges. A Robot may have multiple extension devices onboard, but only one may be deployed at a given time.

[G22]

Robots may only actively control three Basketballs at any time.

Violation: Foul per extra Basketball

Moving or positioning a Basketball to gain advantage is considered actively controlling. Examples are “carrying” (holding Basketballs in the Robot), “herding” (intentionally pushing or impelling Basketballs to a desired location or direction) and “trapping” (pressing one or more Basketballs against a Court element in an attempt to shield them).

Examples of Basketball interaction that are not actively controlling are “bulldozing” (inadvertently coming in contact with Basketballs that happen to be in the path of the Robot as it drives down the Court) and “deflecting” (being hit by a propelled Basketball that bounces or rolls off the Robot).

A Basketball that becomes unintentionally lodged on a Robot will be considered controlled by the Robot. It is important to design your Robot so that it is impossible to inadvertently or intentionally control more than three Basketballs at a time.

[G23]

Robots on the same Alliance may not work together to blockade the Court in an attempt to stop the flow of the Match. This rule has no effect on individual Robot-to-Robot defense.

Violation: Technical-Foul

[G24]

Intentionally falling down or tipping over to block the Court is not allowed.

Violation: Technical-Foul

[G25]

Robots may not contact or otherwise interfere with the opposing Alliance Bridge.

Violation: Technical-Foul. If the act of Balancing is interfered with, also a Red Card and the Bridge will be counted as Balanced.

3.1.5 Robot-Robot Interaction

[G26]

Strategies aimed at the destruction, attachment, damage, tipping or entanglement of Robots are not in the spirit of the FRC and are not allowed.

Violation: Technical-Foul plus Yellow Card

For example, use of wedge-like mechanisms to flip Robots would be considered a violation.

[G27]

Deliberate or damaging contact with an opponent Robot inside its Frame Perimeter is not allowed.

Violation: Technical-Foul and potential Yellow Card

High speed accidental collisions may occur during the Match and are an expected part of the game. Robots place mechanisms outside of the Frame Perimeter at their own risk; no penalties will be assigned for contact between two such extended mechanisms.

A Robot with a mechanism outside of its Frame Perimeter may be penalized under this rule if it appears they are using that mechanism to purposefully contact another Robot inside its Frame Perimeter. Regardless of intent, a Robot with a mechanism outside its Frame Perimeter that causes damage to another Robot inside of its Frame Perimeter will be penalized.

Repeated or egregious violations of this rule will earn the offending Robot a Yellow Card.

[G28]

Robots may not touch an opponent Robot in contact with its Key, Alley, or Bridge.

Violation: Foul; Technical-Foul for purposeful, consequential contact.

This rule applied at all times, no matter who initiates the contact, see [\[G44\]](#).

[G29]

An Alliance may not pin an opponent Robot that is in contact with a Court border, Fender, Barrier or Bridge for more than 5 seconds. A Robot will be considered pinned until the Robots have separated by at least 6 feet. The pinning Robot(s) must then wait for at least 3 seconds before attempting to pin the same Robot again. Pinning is transitory through other objects.

Violation: Technical-Foul

If the pinned Robot chases the pinning Robot upon retreat, the pinning Robot will not be penalized per [\[G44\]](#), and the pin will be considered complete. Pinning a Robot against Basketballs that are being pushed against the Court border is an example of pinning being considered transitory.

[G30]

Fallen (i.e. tipped over) Robots attempting to right themselves (either by themselves or with assistance from an Alliance partner) have one 10-second grace period per fallen Robot in which they may not be contacted by an opposing Robot. This protection lasts for either 10 seconds or until the protected Robots have completed the righting operation, whichever comes first.

Violation: Foul for inadvertent contact; Technical-Foul for obviously intentional contact.

Once the 10-second grace period for righting a fallen Robot has expired, opposing

Robots may interact with a fallen Robot with no Foul assessed as long as [G27] is not violated (as applied to the fallen over Robot).

3.1.6 Human Actions

[G31]

Only Inbounders may contact Basketballs; each Inbounder may hold a maximum of two Basketballs. During Teleop, Inbounders must remove Basketballs from the Corral immediately upon arrival. All Basketballs in the Alliance Station must be held by Inbounders once removed from the Corral.

Violation: Foul

[G32]

During Teleop, Inbounders may enter Basketballs back onto the Court by:

- a. passing through the Inbound Slots at any time;
- b. throwing over the Inbound Station during the final 30 seconds of Teleop.

Violation: Foul

[G33]

During Teleop, Players must be within their Alliance Station. Inbounders who were in the Kinect Station during Hybrid must return safely and expediently to their Alliance Station at the start of Teleop. Inbounders must remain behind the Starting Line during the Match. Exceptions will be allowed in cases involving Player safety.

Violation: Foul

[G34]

Players may not extend any part of their body into the Court or contact any Robot at any time during the Match.

Violation: Technical-Foul

[G35]

If a Robot becomes unsafe (e.g. the Robot begins to smoke, the battery falls out, etc.) it may be disabled for the remainder of the Match by any player by pressing the E-Stop button. The E-Stop buttons are intended for remote shutdown in the event of safety hazards and will not otherwise affect Match score or duration.

Violation: *Technical-Foul* if used for any other reason.

[G36]

During a Match, the operator console shall be operated solely by the Drivers of that team.

Violation: *Technical-Foul*

3.2 Scoring

[G37]

Final scores will be assessed 5 seconds after the Arena timer hits zero.

[G38]

Alliances will be immediately awarded points for each Basketball that passes completely through a Hoop as follows:

Hoop	Points
Top	3
Middle	2
Bottom	1

[G39]

During Hybrid, an additional 3 point bonus will be added for each Basketball that passes completely through any Hoop.

[G40]

When the final score is assessed per [\[G37\]](#), a Balanced Alliance Bridge, per [Section 2.2.5](#), earn points as follows:

# of Robots	Qualification	Elimination
1	10	10
2	20	20
3	20	40

As the level of competition at the *FIRST* Championship is typically very different than during the competition season, the Game Design Committee will possibly alter the value of balancing at the *FIRST* Championship within the range of 5 to 15 points per Robot.

[G41]

If a Robot from each Alliance is balanced on the Coopertition Bridge when the final score for a Qualification Match is assessed per Rule [\[G37\]](#), each Alliance earns 2 Coopertition Points. If the Coopertition Bridge is not balanced, but a Robot from each Alliance is fully supported by the Coopertition Bridge, each Alliance will earn 1 Coopertition Point.

3.3 Fouls

[G42]

Whenever a Foul is committed, 3 points will be credited to the opposing Alliance immediately.

[G43]

Whenever a Technical-Foul is committed, 9 points will be credited to the opposing Alliance immediately.

[G44]

Generally, a rule violation by an Alliance that was directly caused by actions of the opposing Alliance will not be penalized. Rule [\[G28\]](#) is an exception to this rule.

[G45]

Strategies exploiting Rule [\[G44\]](#) are not in the spirit of the FRC and are not allowed.
Violation: Technical-Foul and Red Card

3.4 Revision History

Revision	Release Date	Changes
-	1/3/12	Initial Release

4 The Robot	5
4.1 Robot Rules	5
4.1.1 General Robot Design	5
[R01]	5
[R02]	6
[R03]	6
[R04]	7
[R05]	7
[R06]	7
[R07]	7
4.1.2 Safety & Damage Prevention	7
[R08]	7
[R09]	8
4.1.3 Budget Constraints	8
[R10]	9
[R11]	9
[R12]	9
[R13]	9
[R14]	9
[R15]	10
[R16]	10
[R17]	11
4.1.4 Fabrication Schedule	12
[R18]	12
[R19]	13
[R20]	13
[R21]	13
4.1.5 Material Utilization	13
[R22]	13
[R23]	14
[R24]	14
[R25]	15
[R26]	15
4.1.6 Bumper Rules	15
[R28]	17
[R29]	18
[R30]	18
[R31]	19
[R32]	19
[R33]	19

[R34]	20
[R35]	20
4.1.7 Power Distribution	20
[R36]	20
[R37]	21
[R38]	21
[R39]	21
[R40]	22
[R41]	22
[R42]	22
[R43]	23
[R44]	24
[R45]	24
[R46]	24
[R47]	25
4.1.8 Motors & Actuators	25
[R49]	26
[R50]	26
[R51]	26
4.1.9 Control, Command & Signals System	27
[R52]	27
[R53]	27
[R54]	27
[R55]	28
[R56]	28
[R57]	28
[R58]	29
[R59]	30
[R60]	30
[R61]	30
[R62]	30
[R63]	31
[R64]	31
[R65]	32
[R66]	32
[R67]	32
4.1.10 Pneumatic System	32
[R68]	33
[R69]	33
[R70]	33
[R71]	33

[R72]	34
[R73]	34
[R74]	35
[R75]	35
[R76]	36
[R77]	36
[R78]	36
4.1.11 Operator Console	36
[R79]	36
[R80]	36
[R81]	37
[R82]	37
[R83]	37
[R84]	37
4.2 Revision History	38

This section of the *2012 FRC Game Manual* presents legislation relevant to the construction of a **2012 FIRST[®] Robotics Competition (FRC) Robot. Robots will be Inspected at each FRC event to confirm compliance before being allowed to compete, per [Section 5.5.2](#) in *The Tournament, Eligibility and Inspection of the 2012 FRC Game Manual*.**

4 The Robot

4.1 Robot Rules

Many of the rules listed below explicitly address what and how parts and materials may be used. There are many reasons for the structure of the rules, including safety, reliability, parity, creation of a reasonable design challenge, adherence to professional standards, impact on the competition, compatibility with the KOP, etc. When reading these rules, please use technical common sense (engineering thinking) rather than “lawyering” the interpretation and splitting hairs over the precise wording in an attempt to find loopholes. Try to understand the reasoning behind a rule.

In addition, another intent of these rules is to have all energy sources and active actuation systems on the Robot (e.g. batteries, compressors, motors, servos, cylinders, and their controllers) drawn from a well-defined set of options. This is to ensure that all teams have access to the same actuation resources, and to ensure that the Inspectors are able to accurately assess the legality of a given part.

Some of these rules make use of English unit requirements for parts. If your team has a question about a metric-equivalent part’s legality, please e-mail your question to frcparts@usfirst.org for an official ruling.

4.1.1 General Robot Design

[R01]

Each registered FRC team may enter one Robot into the 2012 FRC. The Robot must be built by the FRC team to perform specific tasks when competing in *Rebound Rumble*. The Robot must include all of the basic systems required to be an active participant in the game – power, communications, control, mobility, and actuation. The Robot implementation must obviously follow a design approach intended to play the 2012 FRC game (e.g. a box of unassembled parts placed on the Court, or a Robot designed to play a different game would not satisfy this definition).

The Robot must have a Frame Perimeter that is comprised of fixed, non-articulated structural elements of the Robot. The Frame Perimeter of a Robot is defined by the outer-most set of exterior vertices on the Robot that are within the Bumper Zone, which is between 2 and 10 in. from the floor. Minor protrusions no greater than ¼ in. such as bolt heads, fastener ends, and rivets are not considered part of the Frame Perimeter.

To determine the Frame Perimeter, wrap a piece of string around the Robot at the level described in [R02]. The string describes this polygon.

Note: to permit a simplified definition of the Frame Perimeter and encourage a tight, robust connection between the Bumpers and the Frame Perimeter, minor protrusions such as bolt heads, fastener ends, rivets, etc are excluded from the determination of the Frame Perimeter.

[R02]

The Robot must satisfy the following size constraints:

- A. horizontal dimensions must not exceed 28 by 38 in.,
- B. the absolute height must not exceed 84 in.,
- C. the height of the Robot at the start of the match must not exceed 60 in.,
- D. any appendage may not extend more than 14 in. beyond the frame perimeter, and
- E. no other part of the Robot may extend beyond the vertical projection of the Frame Perimeter (with the exception of minor protrusions permitted per 0).

Expect to demonstrate the Robot's ability to constrain itself to the envelope defined in Rule 0 to Inspectors.

Please refer to [Section 3: The Game](#) for Robot specific dimension constraints during the Match.

If a Robot is designed as intended and pushed up against a vertical wall (with Bumpers removed and appendages retracted), only the Frame Perimeter (or its minor protrusions) will be in contact with the wall.

[R03]

The Robot weight may not exceed 120 lbs. When determining weight, the basic Robot structure and all elements of all additional Mechanisms that might be used in different configurations of the Robot shall be weighed together.

For the purposes of determining compliance with the weight and volume limitations, the items listed below are not included in the weight assessment:

- A. the 12V battery and its associated half of the Anderson cable quick connect/disconnect pair (including no more than 12 in. of cable per leg, the associated cable lugs, connecting bolts, and insulation) and
- B. Bumpers (including Bumper covers, if appropriate).

[R04]

Robots shall display their school name (or the name of the supporting youth organization, if appropriate), and primary sponsor name and/or logo whenever the Robot is competing.

The support provided by the corporate sponsors and mentors on your team is important, and is to be acknowledged with the appropriate display of their names/logos on the exterior of the Robot.

[R05]

Any non-functional decorations included on the Robot must not affect the outcome of the match and must be in the spirit of Gracious Professionalism.

[R06]

Traction devices may not have surface features such as metal, sandpaper, hard plastic studs, cleats, or other attachments. Traction devices include all parts of the Robot that are designed to transmit any propulsive and/or braking forces between the Robot and the Court.

[R07]

Robots shall not be re-enabled after the Match and must allow removal of Basketballs from the Robot and the Robot from the Court while disabled or powered off.

4.1.2 Safety & Damage Prevention

[R08]

Robot parts shall not be made from hazardous materials, be unsafe, cause an unsafe condition, or interfere with the operation of other Robots.

Examples of items that will violate this rule include (but are not limited to):

- A. Shields, curtains, or any other devices or materials designed or used to obstruct or limit the vision of any drivers and/or coaches and/or interfere with their ability to safely control their Robot
- B. Speakers, sirens, air horns, or other audio devices that generate sound at a level sufficient to be a distraction
- C. Any devices or decorations specifically intended to jam or interfere with the remote sensing capabilities of another Robot, including vision systems, acoustic range finders, sonars, infra-red proximity detectors, etc.(e.g. including imagery on your Robot that, to a reasonably astute observer, mimics the Vision Target)
- D. Exposed lasers other than Class I.
- E. COTS devices with completely enclosed integral lasers, such as a laser ring gyro, are permitted.
- F. Flammable gasses
- G. Any devices intended to produce flames or pyrotechnicsHydraulic fluids or hydraulic components

Teams should provide MSD Sheets for any materials they use that might be considered questionable during Robot Inspection.

[R09]

Protrusions from the Robot and exposed surfaces on the Robot shall not pose hazards to the Arena, Basketballs or people.

If the Robot includes protrusions that form the "leading edge" of the Robot as it drives and are less than 1 in.² in surface area, it will invite detailed Inspection. For example, forklifts, lifting arms, or grapplers. may be carefully Inspected for these hazards.

All points and corners that would be commonly expected to contact a Basketball should have a minimum radius of 0.125 in. to avoid becoming a snag, abrasion, or puncture hazard. All edges that would be commonly expected to contact a Basketball should have a minimum radius of 0.030 in.

4.1.3 Budget Constraints

[R10]

The Kit of Parts (KOP) is the collection of items obtained via any of the following KOP channels:

- Via the Kickoff Kit (items are listed in the [2012 Kickoff Kit Checklist](#)),
- Via the Virtual Kit (details on the [Kit of Parts website](#)),
- and via [FIRST Choice](#).

[R11]

A Component is any part in its most basic configuration, which cannot be disassembled without damaging or destroying the part or altering its fundamental function.

[R12]

A Mechanism is a COTS or custom assembly of Components that provide specific functionality on the Robot. A Mechanism can be disassembled (and then reassembled) into individual Components without damage to the parts.

[R13]

The total cost of all non-KOP items shall not exceed \$3,500.00 USD. All costs are to be determined as explained in [Section 4.1.3: Budget Constraints](#).

The following items are excluded from the total cost calculation:

- A. items listed on any KOP Checklist (qty is limited to the total listed in the most recent checklist),
- B. items obtained via a Product Donation Voucher included in the KOP,
- C. items ever distributed to the team via *FIRST Choice*,
- D. any non-functional decorations,
- E. individual fasteners, adhesives, or lubricants that are less than \$1.00 each,
- F. spare parts, and
- G. parts of the Operator Console.

[R14]

No individual item shall have a value that exceeds \$400.00. The total cost of Components purchased in bulk may exceed \$400.00 USD as long as the cost of an individual Component does not exceed \$400.00.

Teams should be prepared to prove to Inspectors the cost of any non-KOP item and the total cost of the Robot.

Per [Section 5, The Tournament](#), teams should be prepared to display a BOM to Inspectors during Inspection. The BOM may be displayed in either printed or electronic form.

[R15]

Individual Components or Mechanisms, not excluded in Rule [\[R10\]](#), that are retrieved from previous Robots and used on 2012 Robots must have their undepreciated cost included in the 2012 Robot cost accounting and applied to the overall cost limits.

[R16]

The Bill of Materials cost of each non-KOP item must be calculated based on the unit fair market value for the material and/or labor, except for labor provided by team members (including sponsor employees who are members of the team) and shipping.

Example: A team orders a custom bracket made by a company to the team's specification. The company's material cost and normally charged labor rate apply.

Example: A team receives a donated sensor. The company would normally sell this item for \$52, which is therefor its fair market value.

Example: Special price discounts from National Instruments and Texas Instruments are being offered to all *FIRST* teams. The discounted purchase price of items from these sources would be used in the additional parts accounting calculations.

Example: A team purchases steel bar stock for \$10.00 and has it machined by a local machine shop. The machine shop is not considered a team sponsor, but donates two hours of expended labor anyway. The team must include the estimated normal cost of the labor as if it were paid to the machine shop, and add it to the \$10.00.

Example: A team purchases steel bar stock for \$10.00 and has it machined by a local machine shop that is a recognized sponsor of the team. If the machinists are considered members of the team, their labor costs do not apply. The total applicable cost for the part would be \$10.00.

It is in the best interests of the teams and *FIRST* to form relationships with as many organizations as possible. Teams are encouraged to be expansive in recruiting and including organizations in their team, as that exposes more people and organizations to *FIRST*. Recognizing supporting companies as sponsors of, and members in, the team is encouraged - even if the involvement of the sponsor is solely through the donation of fabrication labor.

Example: A team purchases a 4 by 4 ft sheet of aluminum, but only uses a piece 10 by 10 in. on their Robot. The team identifies a source that sells aluminum sheet in 1 by 1 ft pieces. The team may cost their part on the basis of a 1 by 1 ft piece, even though they cut the piece from a larger bulk purchase. They do not have to account for the entire 4 by 4 ft bulk purchase item.

[R17]

If the item is part of a modular system that can be assembled in several possible configurations, then each individual module must fit within the price constraints defined in Rule [\[R14\]](#).

If the modules are designed to assemble into a single configuration, and the assembly is functional in only that configuration, then the total cost of the complete assembly including all modules must fit within the price constraints defined in Rule [\[R14\]](#).

In summary, if a Vendor sells a system or a kit, a team must use the entire system/kit Fair Market Value and not the value of its Component pieces.

Example1: Vendor A sells a gearbox that can be used with a number of different gearsets, and can mate with two different motors they sell. A team purchases the gearbox, a gearset, and a motor (which are not offered together as an assembly or kit), then assembles them together. Each part is treated separately for the purpose of Bill of Materials costing, since the purchased pieces can each be used in various configurations.

Example2: Vendor B sells a robotic arm assembly that the team wants to use. However, it costs \$700, so they cannot use it. The Vendor sells the “hand”, “wrist” and “arm” as separate assemblies, for \$200 each. A team wishes to purchase the three components separately, then reassemble them. This would not be legal, as they are really buying and using the entire assembly, which has a Fair Market Value of \$700.

4.1.4 Fabrication Schedule

[R18]

Robot elements designed or created before the Kickoff presentation, including software, are not permitted.

Please note that this means that Fabricated items from Robots entered in previous *FIRST* competitions may not be used on Robots in the 2012 FRC. Before the formal start of the Robot Build Season, teams are encouraged to think as much as they please about their Robots. They may develop prototypes, create proof-of-concept models, and conduct design exercises. Teams may gather all the raw stock materials and COTS Components they want.

Example: A team designs and builds a two-speed shifting transmission during the fall as a training exercise. When designing their competition Robot, they utilize all the design principles they learned. To optimize the transmission design for their Robot, they improve the transmission gear ratios and reduce the size, and build two new transmissions, and place them on the Robot. All parts of this process are permitted activities.

Example: The same team realizes that the transmission designed and built in the fall perfectly fits their need for a transmission to drive the Robot arm. They build an exact copy of the transmission from the original design plans, and bolt it to the Robot. This would be prohibited, as the transmission – although fabricated during the competition season – was built from detailed designs developed prior to Kick-off.

Example: A team developed an omni-directional drive system for the 2011 competition. Over the summer of 2011 they refined and improved the control software (written in C) to add more precision and capabilities. They decided to use a similar system for the 2012 competition. They copied large sections of unmodified code over into the control software of the new Robot (also written in C). This would be a violation of the schedule constraint, and would not be allowed.

Example: The same team decides to use the LabVIEW as their software environment for 2012. Following kickoff, they use the previously-developed C code as a reference for the algorithms and calculations required to implement their omni-directional control solution. Because they developed new LabView code as they ported over their algorithms, this would be permitted.

Example: A different team develops a similar solution during the fall, and plans to use the developed software on their competition Robot. After completing the software, they post it in a generally accessible public forum and make the code available to all teams. Because they have made their software generally available (per the definition of COTS, it is considered COTS software and they can use it on their Robot).

[R19]

The Robot (including items intended for use during the competition in alternative configurations of the Robot, excluding items permitted per Rule [\[R26\]](#)) must be bagged or crated (as appropriate for your event), and out of team hands by the shipment deadline specified in the [FRC Administrative Manual, Section 5](#).

[R20]

Teams must stay “hands-off” their Robot from Stop Build Day until their first competition, during the period(s) between their competitions, and outside of pit hours while attending competitions; there are no restrictions on when software may be developed. Specific exceptions are as follows:

- A. On days a team is not attending an event, they may continue development of any items permitted per Rule [\[R25\]](#), but must do so without interfacing with the Robot.
- B. Teams attending 2-day events may access their Robots per the rules defined in the [Administrative Manual, Section 5.7, Robot Access Period - for Teams Attending 2-Day Events](#).

[R21]

At competitions, teams may only produce Fabricated Items in the pits or competition-provided machine shops, as defined in the [Administrative Manual, Section 4.8, The Pit](#).

4.1.5 Material Utilization

[R22]

A Commercial, Off-The-Shelf (COTS) item is defined as a part in its unaltered, unmodified state. A COTS item is a

standard (i.e. not custom order) part that is or at one time been commonly available from a Vendor. Once a COTS item is modified in any way, it becomes a Fabricated Item.

[R23]

A Vendor is a legitimate business source for COTS items that satisfies all of the following criteria:

- A. The Vendor must have a Federal Tax Identification number. In cases where the Vendor is outside of the United States, they must possess an equivalent form of registration or license with the government of their home nation that establishes and validates their status as a legitimate business licensed to operate within that country.
- B. The Vendor shall not be a “wholly owned subsidiary” of an FRC team or collection of FRC teams. While there may be some individuals affiliated with both an FRC team and the Vendor, the business and activities of the team and Vendor must be completely separable.
- C. The Vendor must be able to ship any general (i.e., non-*FIRST* unique) product within five business days of receiving a valid purchase request. It is recognized that certain unusual circumstances (such as 1,000 *FIRST* teams all ordering the same part at once from the same Vendor) may cause atypical delays in shipping due to backorders for even the largest Vendors. Such delays due to higher-than-normal order rates are excused.
- D. The Vendor should maintain sufficient stock or production capability to fill teams’ orders within a reasonable period during the build season (less than 1 week). (Note that this criterion may not apply to custom-built items from a source that is both a Vendor and a fabricator. For example, a Vendor may sell flexible belting that the team wishes to procure to use as treads on their drive system. The Vendor cuts the belting to a custom length from standard shelf stock that is typically available, welds it into a loop to make a tread, and ships it to a team. The fabrication of the tread takes the Vendor two weeks. This would be considered a Fabricated Item, and the two weeks ship time is acceptable.) Alternately, the team may decide to fabricate the treads themselves. To satisfy this criterion, the Vendor would just have to ship a length of belting from shelf stock (i.e. a COTS item) to the team within five business days and leave the welding of the cuts to the team.)
- E. The Vendor makes their products available to all FRC teams. Vendor must not limit supply or make a product available to just a limited number of FRC teams.

The intent of this definition is to be as inclusive as possible to permit access to all legitimate sources, while preventing ad hoc organizations from providing special-purpose products to a limited subset of teams in an attempt to circumvent the cost accounting rules. FIRST desires to permit teams to have the broadest choice of legitimate sources possible, and to obtain COTS items from the sources that provide them with the best prices and level of service available. Teams also need to protect against long delays in availability of parts that will impact their ability to complete their Robot. The FRC build season is brief, so the Vendor must be able to get their product, particularly *FIRST* unique items, to a team in a timely manner. Ideally, chosen Vendors should have national distributors (e.g. Home Depot, Lowe's, MSC, Radio Shack, McMaster-Carr, etc.). Remember, FRC events are not usually near home – when parts fail, local access to replacement materials is often critical.

[R24]

COTS items from Robots entered in previous FRC competitions or COTS items that are no longer commercially available may be used only if they are functionally equivalent to the original condition as delivered from the Vendor (e.g. a part that has non-functional label markings added would be permitted, but a part that has device-specific mounting holes added would be prohibited).

[R25]

Lubricants may be used only to reduce friction within the Robot. Lubricants shall not be allowed to contaminate the Court or other Robots.

[R26]

Teams may bring a maximum of 30 lbs of Fabricated Items to each competition event to be used to repair and/or upgrade their Robot at the competition site. The Operator Console and any battery assemblies (see [\[R03\]-A](#)) are not applicable.

4.1.6 Bumper Rules

Robots are required to use Bumpers to protect all exterior vertices of the Frame Perimeter. For adequate protection, at least 8 in. of Bumper must be placed on each side of each exterior vertex (see Figure 4?1, Figure 4?2, and Figure 4?3).

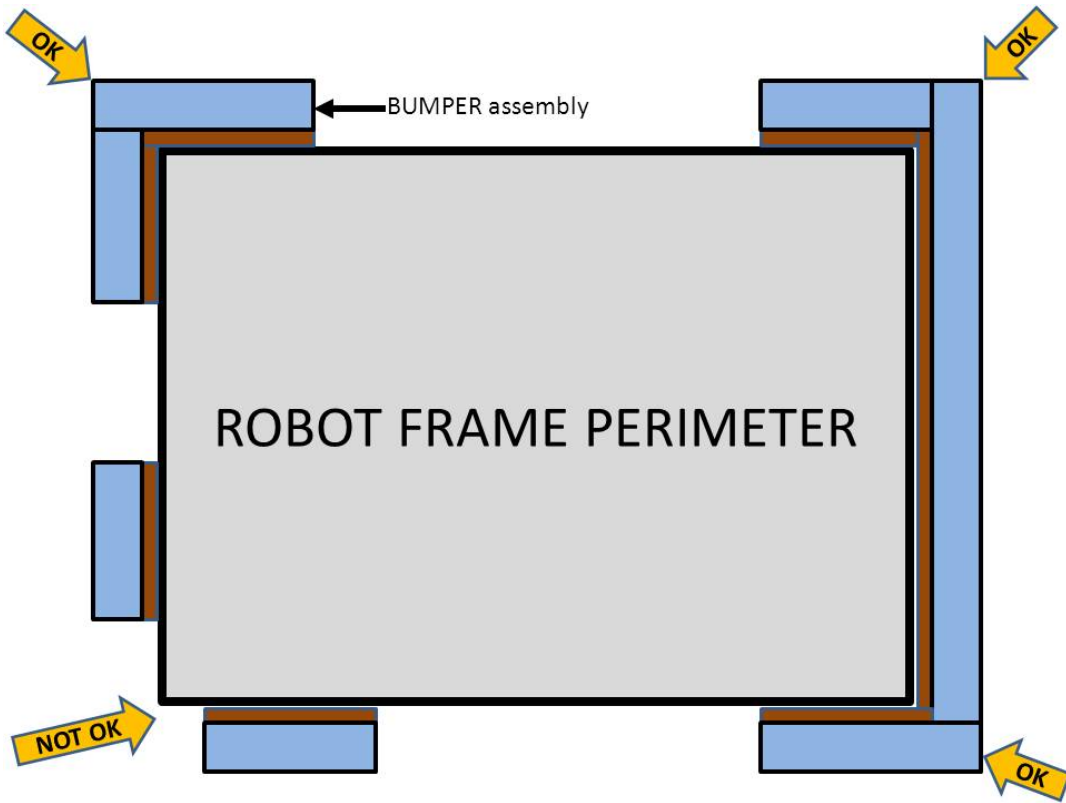

Figure 4-1

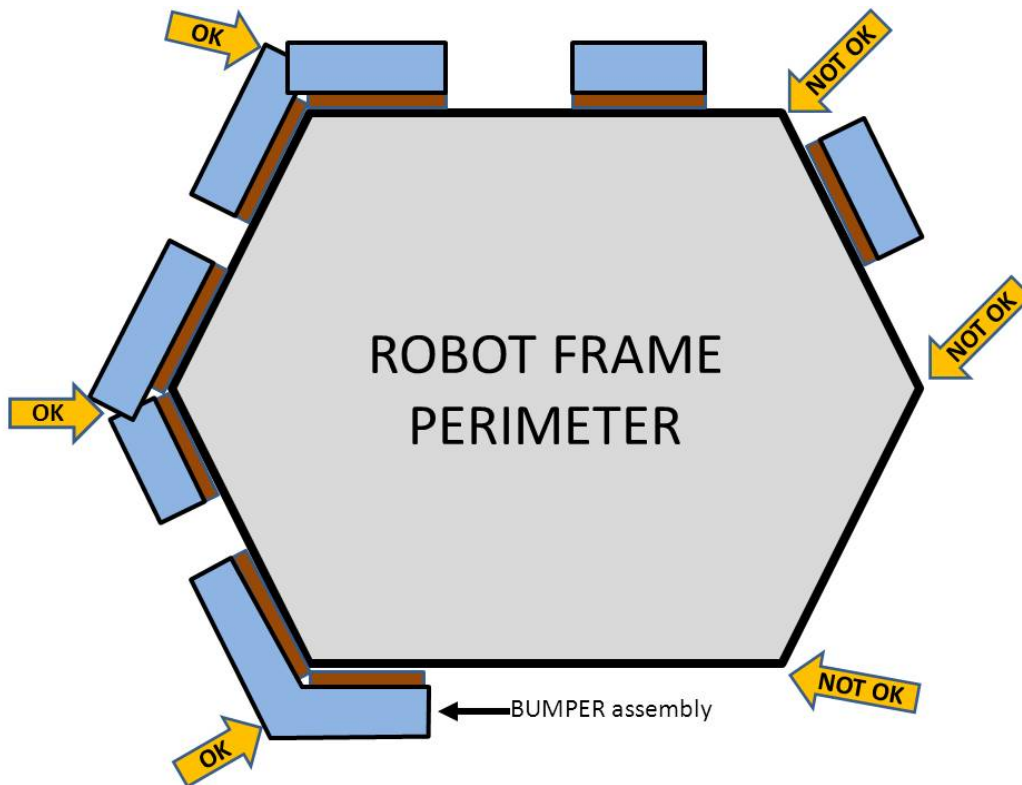

Figure 4-2

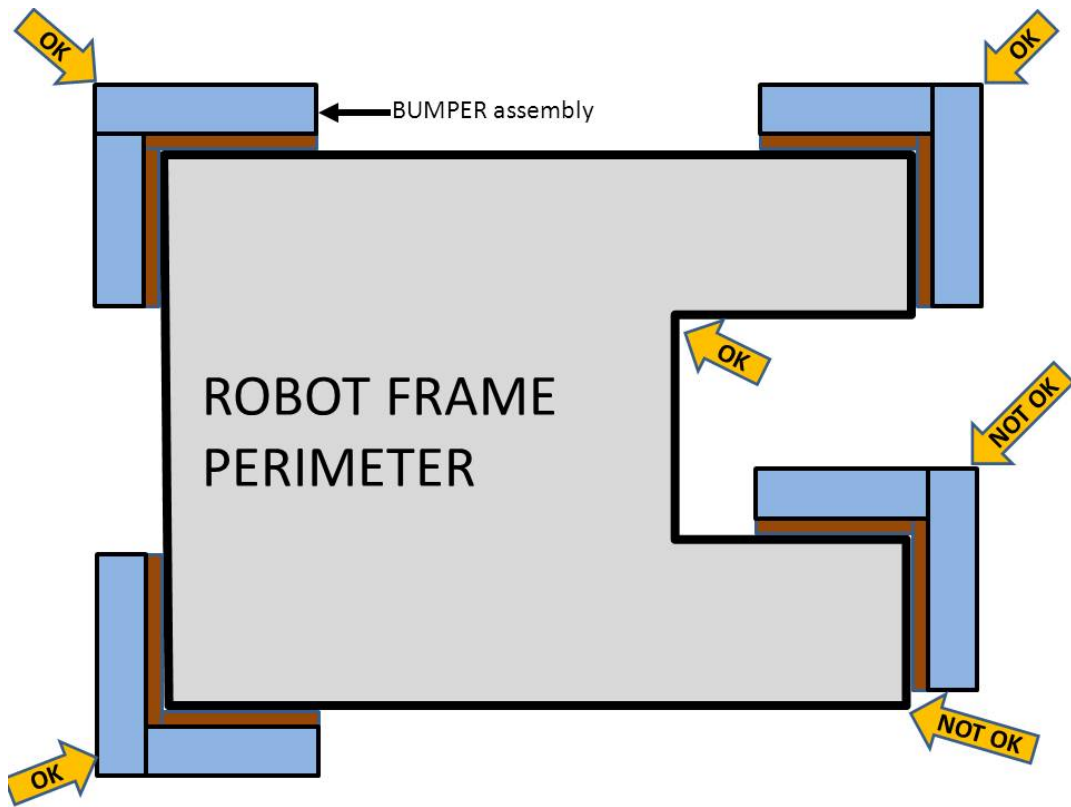

Figure 4-3

[R28]

Bumpers must be constructed as follows (see Figure 4?4):

- A. be backed by $\frac{3}{4}$ in. (nominal) thick by 5 in. tall plywood.
- B. hard Bumper parts (e.g. plywood, fasteners, etc) may not extend more than 1 in. beyond the end of the Frame Perimeter(see Figure 4?4).

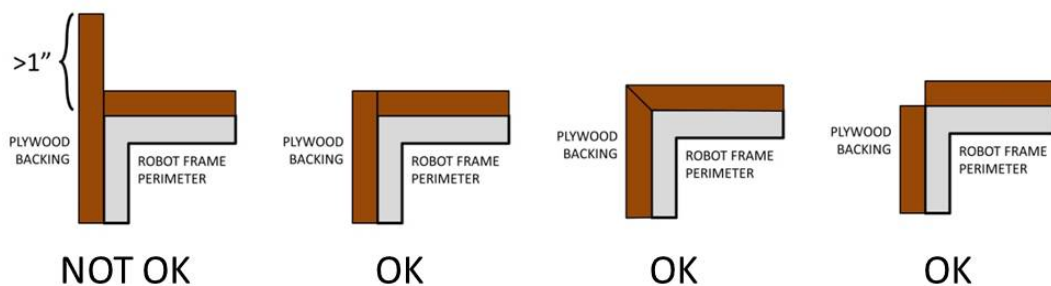

Figure 4-4

- C. use a stacked pair of 2- $\frac{1}{2}$ in. “pool noodles” as the bumper cushion material which completely covers the plywood. Cushion material may extend up to 2- $\frac{1}{2}$ in. beyond the end of the plywood.
- D. be covered with a rugged, smooth cloth. The cloth must completely enclose all exposed surfaces of the plywood and pool noodle material. The fabric covering the Bumpers must be a solid red or blue in color. Visually, the red or blue must be as close to the corresponding color in the *FIRST* logo as reasonable (i.e.

to a reasonably astute observer, they appear similar). The only markings permitted on the Bumper fabric cover are the team number (see Rule [R35]).

- E. must attach to the Frame Perimeter of the Robot with a rigid fastening system to form a tight, robust connection to the main structure/frame (e.g. not attached with Velcro). The attachment system must be designed to withstand vigorous game play. All removable fasteners (e.g. bolts, locking pins, pip-pins, etc.) will be considered part of the Bumpers.
- F. Each set of Bumpers (including any fasteners and/or structures that attach them to the Robot) must weigh no more than 20 lbs.

If a multi-part attachment system is utilized (e.g. interlocking brackets on the Robot and the Bumper), then the elements permanently attached to the Robot will be considered part of the Robot, and the elements attached to the Bumpers will be considered part of the Bumper. Each element must satisfy all applicable rules for the relevant system.

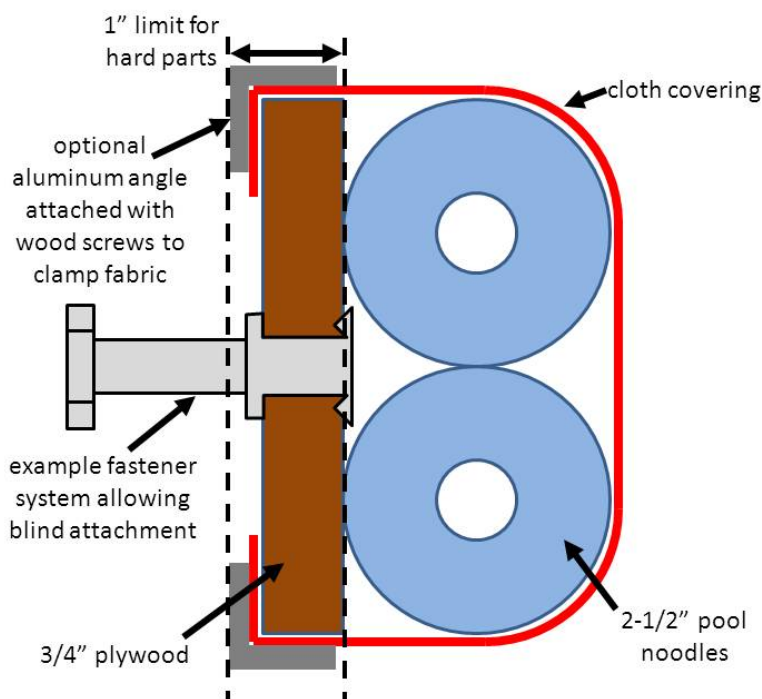

Figure 4-5

[R29]

Bumpers must be located entirely within the Bumper Zone when the Robot is standing normally on a flat floor.

[R30]

Bumpers may not be articulated.

[R31]

Joints between Bumpers and the radial projections of corners must be filled with pool noodle material. Examples of implementation are shown in Figure 4?6.

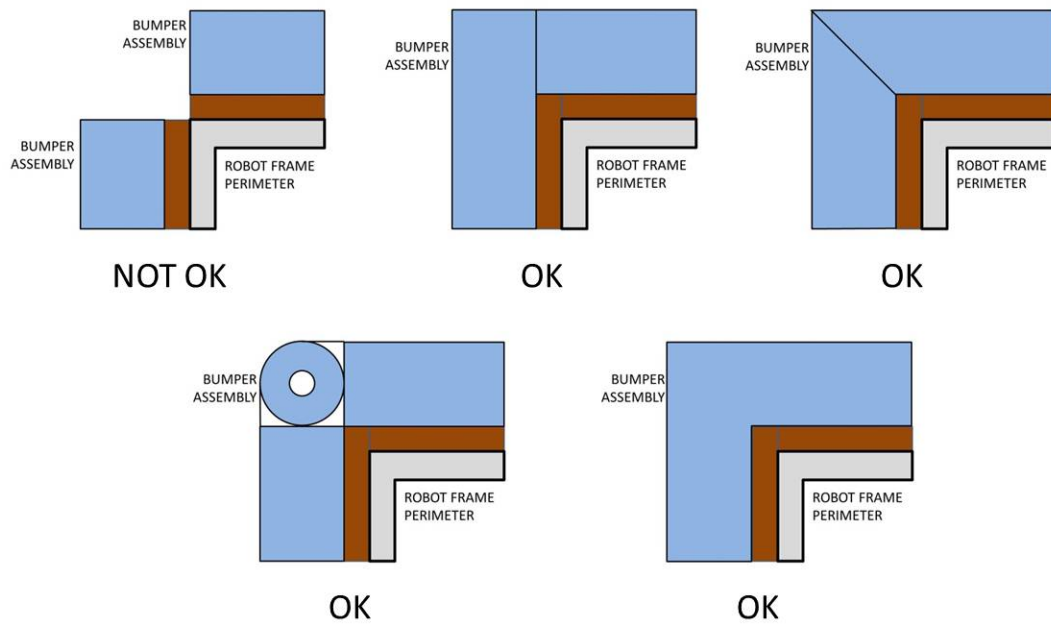

Figure 4-6

[R32]

Bumpers must be designed for quick and easy installation and removal to aid in weighing and Inspection.

As a guideline, Bumpers should be removable by one person in less than 10 minutes.

[R33]

Bumpers must be supported by the structure/frame of the Robot (i.e. the gap between the backing material and the frame must not be greater than 1/4 in. and no section of Bumper greater than 8 in. may be unsupported). See Figure 4-7.

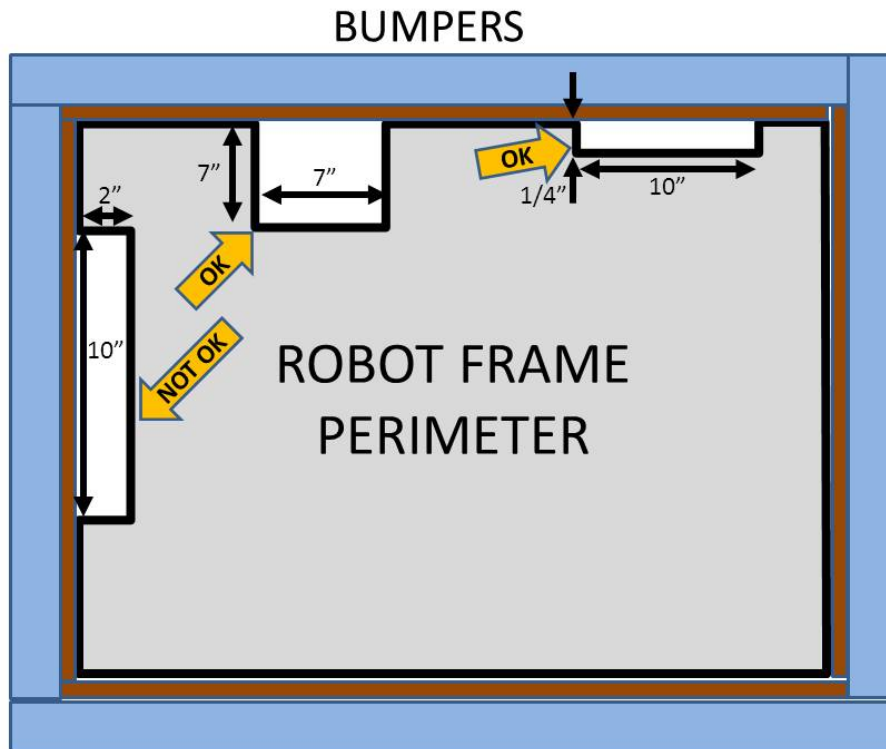

Figure 4-7

[R34]

Each Robot must be able to display red or blue Bumpers to match their alliance color.

[R35]

Teams shall display their team number on the Bumpers in four locations at approximately 90° intervals around the perimeter of the Robot. The numerals must be at least 4 in. high, at least 3/4 in. in stroke width, and be either white in color or outlined in white. Team numbers must be clearly visible from a distance of not less than 100 ft, so that judges, referees, and announcers can easily identify competing Robots.

4.1.7 Power Distribution

[R36]

The only legal source of electrical energy for the Robot during the competition is one MK ES17-12 12VDC non-spillable lead acid battery, or one EnerSys NP 18-12 battery, as provided in the 2012 KOP. This is the only battery allowed on the Robot.

Batteries integral to and part of a COTS computing device are also permitted (i.e. laptop batteries), provided they're only used to power the COTS computing device.

[R37]

Items specifically *prohibited* from use on the Robot include:

- A. circuit breakers used on the Power Distribution (PD) Board that are different from the Snap Action breakers provided in the KOP,
- B. PD Boards and/or fuse panels other than the single PD Board provided in the KOP since 2009, and

[R38]

All wiring and electrical devices, including all control system components, shall be electrically isolated from the Robot frame. The Robot frame must not be used to carry electrical current.

The chassis for the cRIO and the supplied KOP camera have grounded enclosures. Under this rule (and for their protection), it is required that they be electrically isolated from the Robot frame when installed on the Robot.

[R39]

The 12V battery, the main 120-amp circuit breaker, and the PD Board shall be connected as shown in Figure 4?8.

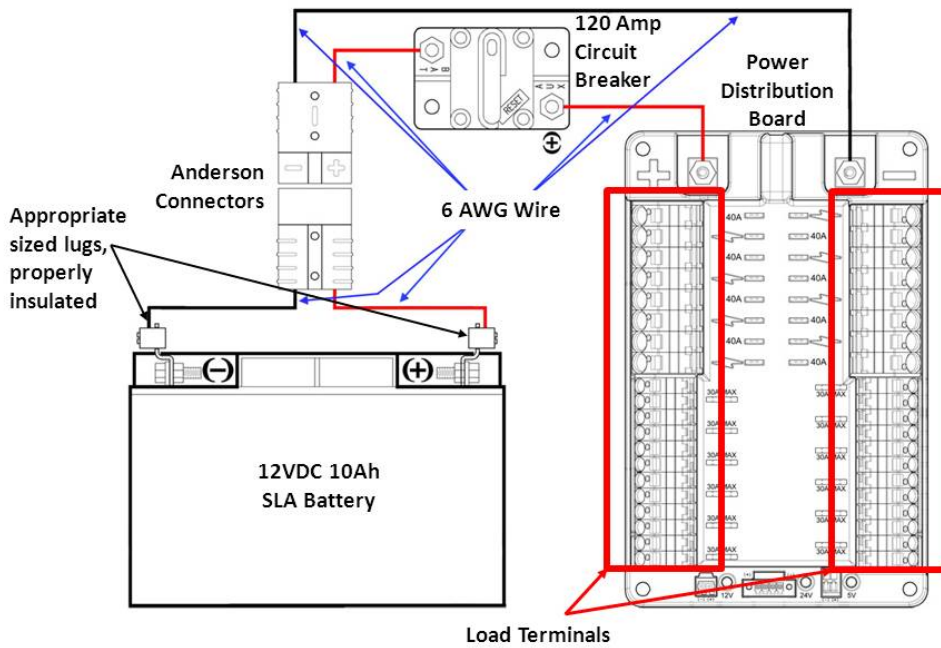

Figure 4-8

[R40]

The 120-amp circuit breaker must be quickly accessible from the exterior of the Robot.

It is recommended that the 120-amp circuit breaker location be clearly and obviously labeled to permit it to be easily found by Arena staff during a match.

[R41]

The PD Board and all circuit breakers must be easily visible for Inspection.

[R42]

All electric power utilized by the Robot shall be distributed from the load terminals of the PD Board (not the M6 shanks).

- A. The cRIO power input must be connected to the 24 Vdc supply terminals on the PD Board. With the exception of one Solenoid Breakout Board, no other electrical load can be connected to these terminals.
- B. The wireless bridge power feed must be supplied by the 5V converter (model # TBJ12DK025Z) connected to the marked 12 Vdc supply terminals located at the end of the PD Board (i.e. the terminals located between the indicator LEDs, and not the main WAGO connectors along the sides of the PD Board). No other electrical load can be connected to these terminals (please reference any *2012 Robot Power Distribution Diagram* posted on the [Kit of Parts site](#) for wireless bridge wiring information).
- C. All other branch circuits must connect to, and have power sourced solely by, a protected 12 Vdc WAGO connector pair or the 5V supply on the PD Board.
- D. Only one wire shall be connected to each WAGO connector on the PD Board. If multi-point distribution of circuit power is required (e.g. to provide power to the three KOP breakout boards via one 20-amp circuit), then all incoming wires must be appropriately spliced into the main lead, and only one lead inserted into the WAGO connector to connect the circuit.

[R43]

All active PD Board branch circuits shall be protected from overload with an appropriate value auto resetting Snap Action circuit breaker. Specifically,

- A. Each speed controller branch circuit must be protected by one and only one 20-amp, 30-amp, or 40-amp circuit breaker on the PD Board (from the KOP or identical equivalent). No other electrical load can be connected to the breaker supplying this circuit.
- B. Each relay module branch circuit must be protected with one and only one 20-amp circuit breaker on the PD Board (from the KOP or identical equivalent). No other electrical load can be connected to the breaker supplying this circuit.
- C. Each Digital Sidecar branch circuit must be protected with one and only one 20-amp circuit breaker on the PD Board (from the KOP or identical equivalent). No other electrical load can be connected to the breaker supplying this circuit.
- D. If a compressor is used, the relay module branch circuit supplying the compressor must be protected with a 20-amp circuit breaker (from the KOP or identical equivalent). No other electrical load can be connected to the breaker supplying this circuit.
- E. A single branch supply circuit may be spliced to supply power to one, two or three of the Analog/Solenoid Breakout Boards. This circuit must be protected with one and only one 20-amp circuit breaker on the PD Board (from the KOP or identical equivalent). No other electrical load can be connected to the breaker supplying this circuit.

Please note, per [\[R64\]](#), that for an 8-slot cRIO, the circuit may not exceed 16W. For a 4-slot cRIO, the circuit may not exceed 21W.

Smaller value Snap Action auto resetting breakers may be used on the PD Board for circuitry not defined above.

In addition to the required branch power circuit breakers, smaller value fuses or breakers may be incorporated into custom circuits for additional protection.

[R44]

All active circuits shall be wired with appropriately sized wire:

Application	Minimum wire size
40A circuit	12 AWG (2.052mm)
30A circuit	14 AWG (1.628mm)
20A circuit	18 AWG (1.024mm)
between the PD Board and the Analog and/or Solenoid Breakouts if a common power feed is used	
between the PD Board and the Analog and/or Solenoid Breakouts if individual power feeds are used	20 AWG (0.8128mm)
between the PD Board and the cRIO	
between the PD Board and the wireless bridge	
between the PD board and 5A custom circuits pneumatic valves	24 AWG (0.5106mm)

The branch circuit may include intermediate elements such as COTS connectors, splices, COTS flexible/rolling/sliding contacts, and COTS slip rings, as long as the entire electrical pathway is via appropriately gauged conductors.

Wires that are originally attached to legal devices are part of the device and by default legal as supplied. Such wires are exempt from Rule [\[R44\]](#).

[R45]

All active circuit wiring with a constant polarity (i.e., except for outputs of relay modules, speed controllers, or sensor outputs) shall be color-coded as follows:

- A. Use red, white, brown, or black with stripe wire on the +24 Vdc, +12 Vdc and +5 Vdc connections.
- B. Use black or blue wire for the common or negative side of the (-) connections.

[R46]

Each power-regulating device (speed controller or relay module) shall control one and only one electrical load (motor, actuator, electric solenoid, or compressor).

Exception: Multiple low-load, pneumatic solenoid valves or lights may be connected to a single relay module. This would allow one relay module to drive multiple pneumatic actions or multiple lights. No other electrical load can be connected to a relay module used in this manner.

[R47]

Custom circuits shall not directly alter the power pathways between the battery, PD Board, speed controllers, relays, motors, or other elements of the Robot control system (including the power pathways to other sensors or circuits). Custom high impedance voltage monitoring or low impedance current monitoring circuitry connected to the Robot's electrical system is acceptable, if the effect on the Robot outputs is inconsequential.

4.1.8 Motors & Actuators

The only motors and actuators permitted on 2012 FRC Robots include:

- A. up to 4 CIM motors (part #FR801-001, M4-R0062-12, AM802-001A, or PMR25R-45F-1003),
- B. up to 4, in any combination, of the BaneBots motors provided in the KOP (acceptable part numbers are M7-RS775-12, M7-RS775-18, M5-RS550-12, M5-RS550-12-B, and M3-RS395-12),
- C. up to 2 window motors (acceptable part #s are 262100-3030 and 262100-3040),
- D. up to 2 FisherPrice motors (acceptable part #s are 00968-2719, 00801-0673, and 00968-9015),
- E. up to 2 AndyMark motors (acceptable part # is am-9012),
- F. up to 2 AndyMark gearmotors (acceptable part # is am-9014),
- G. up to 2 Denso throttle control motors (acceptable part # AE2351000)
- H. up to 2 Vex motors (acceptable part # 276-2177)
 - I. up to 2 window lift, seat, windshield wiper or door motors obtained through either the *FIRST*-Automotive Recyclers Association partnership or from a prior years' KOP.

Note: It will be up to the teams to show that the motors used on the Robot are legal by providing paperwork showing the motor's original use, i.e. if it's called a "seat motor" on the ARA receipt, it is a seat motor.

- J. electrical solenoid actuators, no greater than 1 in. stroke and no greater than 10 watts continuous duty,
- K. drive motors or fans that are part of a speed controller or COTS computing device
- L. an unlimited number of COTS servos with a maximum power rating of 4W each

Servo Max Power Rating = (Stall Torque) X (No Load Speed)

[R49]

Motors, servos, and electric solenoids used on the Robot shall not be modified in any way, except as follows:

- A. The mounting brackets and/or output shaft/interface may be modified to facilitate the physical connection of the motor to the Robot and actuated part.
- B. The electrical input leads may be trimmed to length as necessary.
- C. The locking pins on the window motors (PN 262100-3030 and 262100-3040) may be removed.
- D. The connector housings on the window motors (PN 262100-3030 and 262100-3040) may be modified to facilitate lead connections.

The intent of this rule is to maintain the maximum power level for each Robot, yet still allow teams to modify mounting tabs and the like, not to gain a weight reduction by potentially compromising the structural integrity of any motor. The integral mechanical and electrical system of the motor is not to be modified.

Note that for the Window motors and the AndyMark gearmotor, the gearboxes are considered integral to the motor, thus the motor may not be used without the gearbox.

[R50]

All electrical loads (motors, actuators, compressors, electric solenoids) must be supplied by an approved power regulating device (speed controller, relay module, or Digital Sidecar PWM port) that is controlled by the cRIO on the Robot.

- a. Each CIM motor and Fisher-Price motor must be connected to one and only one approved speed controller. These motors must not be connected to relay modules.
- b. Servos must be directly connected to the PWM ports on the Digital Sidecar. They must not be connected to speed controllers or relay modules.
- c. If used, the compressor must be connected to one and only one approved relay module.
- d. Each other electrical load (motor or actuator) must be supplied by one and only one approved speed controller, or one and only one relay module.
- e. Electric solenoids may alternatively be supplied by the Solenoid Breakout Board connected to the NI 9472 cRIO module.

[R51]

The only power regulating devices for actuators permitted on 2012 FRC Robots include:

- A. Jaguar motor controller (PNs MDL-BDC and MDL-BDC24),
- B. Victor motor controller (PN FR-VIC884)
- C. Vex motor controller (PN 276-2193)
- D. Spike Relay module (PN SPIKE-RELAY-H)

To seek approval for alternate devices for inclusion in future FRC seasons, please contact frcparts@usfirst.org with the item specifications.

4.1.9 Control, Command & Signals System

[R52]

Robots must be controlled via one programmable National Instruments cRIO (part # cRIO-FRC or cRIO-FRCII), with image version FRC_2012_v43. Other controllers shall not be used.

As long as the CAN bus is wired legally so that the heartbeat from the cRIO is maintained, all closed loop control features of the Jaguar motor controller may be used. (That is, commands originating from the cRIO to configure, enable, and specify an operating point for all Jaguar closed loop modes fit the intent of [R53].)

[R53]

Connections to the cRIO Ethernet ports must be compliant with the following parameters:

- A. The DAP-1522 wireless bridge is connected to the cRIO Ethernet port 1 (either directly or via a CAT5 Ethernet pigtail).
- B. Ethernet-connected COTS devices or custom circuits may connect to any remaining Ethernet ports; however, these devices may not transmit or receive UDP packets using ports 1100-1200 except for ports 1130 and 1140.

[R54]

The cRIO, Driver Station software, and wireless bridge must be configured to correspond to the correct team number (assigned to the team by *FIRST*), per the procedures defined in the FRC control system documentation

[R55]

One D-Link DAP-1522 is the only permitted device for communicating to and from the Robot during the match. All signals must originate from the Operator Console and be transmitted to the Robot via the official Arena hardware. No other form of wireless communications shall be used to communicate to, from or within the Robot (e.g. radio modems from previous *FIRST* competitions and Bluetooth devices are not permitted on the Robot during competition).

Teams are encouraged to mount the wireless bridge away from noise generating devices such as the CIM motors. By making the diagnostic lights visible, Arena personnel are in a better position to assist teams.

[R56]

The DAP-1522 wireless bridge must be mounted on the Robot such that the diagnostic lights are visible to Arena personnel.

[R57]

Robots shall use the diagnostic Robot Signal Light (RSL) provided in the KOP. It must be mounted on the Robot such that it is easily visible while standing three feet in front of the Robot.

A. The RSL must be connected to the "RSL" supply terminals on a Digital Sidecar

See the 2012 Robot Data Diagram on the [KOP website](#) and the item bulletin online [here](#) for connection details.

- B. The Digital Sidecar must be connected to a NI 9403 module in Slot 2 of the cRIO.
- C. The RSL must be wired for “solid light” operation, by placing a jumper between the La and Lb terminals on the light per Figure 4-9.

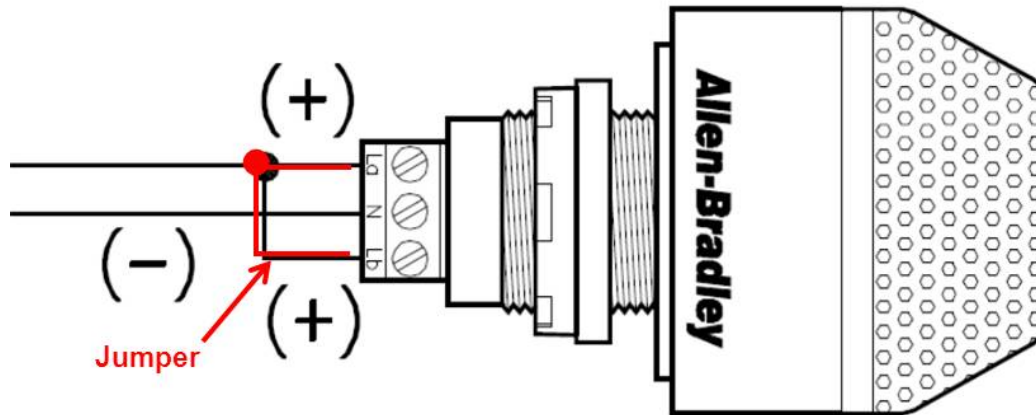

Figure 4-9

[R58]

The control system is designed to allow wireless control of the Robots. The Driver Station software, FirstTouch I/O module, cRIO, speed controllers, relay modules, wireless bridge, and batteries shall not be tampered with, modified, or adjusted in any way (tampering includes drilling, cutting, machining, gluing, rewiring, disassembling, etc.), with the following exceptions:

- A. User programmable code in the cRIO may be customized.
- B. Dip switches on the cRIO may be set.
- C. Speed controllers may be calibrated as described in owner's manuals.
- D. The supplied fans attached to speed controllers may be powered from the power input terminals.
- E. The fuse on a relay feeding the compressor may be replaced with a 20 Amp Snap-Action circuit breaker (recommended).
- F. Wires, cables, and signal lines may be connected via the standard connection points provided on the devices.
- G. Fasteners may be used to attach the device to the Operator Console or Robot.
- H. Labeling may be applied to indicate device purpose, connectivity, functional performance, etc.
 - I. Brake/Coast jumpers on speed controllers may be changed from their default location.
- J. Limit switch jumpers may be removed from a Jaguar speed controller and a custom limit switch circuit may be substituted.
- K. If CAN-bus functionality is used, the Jaguar firmware may (must) be updated as required by *FIRST* (see Rule [\[R61\]-D](#)).
- L. The First Touch I/O module's firmware may be modified.
- M. Devices may be repaired, provided the performance and specifications of the component after the repair are identical to those before the repair.

Please note that the Driver Station application is a separate application from the Dashboard. The Driver Station software may not be modified, while teams are expected

to customize their Dashboard code.

Note that if you are using the FirstTouch I/O module as part of the Operator Console, you should not update the firmware if the manufacturer releases a new version. The new version will wipe out the FIRST custom firmware and your FirstTouch I/O module will no longer function with the Driver Station software. If a team does wipe out the FIRST custom firmware, it can be restored via the most recent Driver Station update.

Please note that while repairs are permitted per the FRC Game Manual, the allowance is independent of any manufacturer's warranty. Teams make repairs at their own risk and should assume that any warranty or RMA options are forfeited. Be aware that diagnosing and repairing components such as these can be difficult.

[R59]

Neither 12Vdc power nor relay module, speed controller, or PWM outputs may be connected to the analog/solenoid breakout boards or the Digital Sidecar (with the exception of the designated 12Vdc input terminals).

[R60]

Every relay module, servo, and PWM speed controller shall be connected via PWM cable to the Digital Sidecar and be controlled by signals provided from the cRIO via the Digital Sidecar. They shall not be controlled by signals from any other source.

[R61]

Each Jaguar must be controlled with signal inputs sourced from the cRIO and passed via either a connected PWM cable or a CAN-bus connection.

- A. The Jaguar must receive signals via either a PWM cable -OR- a CAN-bus connection. Both may not be used simultaneously.
- B. PWM configuration: If the Jaguar speed controller is controlled via PWM communications, the PWM port on the Jaguar speed controller must be connected directly to a PWM port on the Digital Sidecar with a PWM cable. No other devices may be connected to these PWM ports. No other devices may be connected to any other ports on the Jaguar speed controller with the exception of connection to the coast/brake port.
- C. CAN-bus configuration: If the Jaguar speed controller is controlled via CAN-bus communications, then each Jaguar speed controller must be connected to either the cRIO or another CAN-bus device with a CAN-bus cable.
- D. If the CAN-bus configuration is used, the firmware on all Jaguar speed controllers must be updated to at least Version 94 of the official *FIRST* firmware.

[R62]

If CAN-bus communications are used, the CAN-bus must be connected to the cRIO through either the Ethernet network connected to Port 1, Port 2, or the DB-9 RS-232 port connection.

- A. Ethernet-to-CAN bridges or RS-232-to-CAN bridges (including the “black” Jaguars, MDL-BDC24) may be used to connect the CAN-bus to the cRIO.
- B. Additional switches, sensor modules, custom circuits, third-party modules, etc. may also be placed on the CAN-bus.
- C. No device that interferes with, alters, or blocks communications between the cRIO and the Jaguars will be permitted (tunneling packets for the purposes of passing them through an Ethernet-to-CAN bridge is acceptable as the commands are not altered).

[R63]

Outputs from each Solenoid Breakout shall not cumulatively exceed 16W for the cRIO-FRC (8-slot) and 21W for the cRIO-FRC II (4-slot).

[R64]

A National Instruments 9201 module must be installed in slot 1 of the cRIO . An analog breakout must be connected to this module. A jumper must be installed in the “Power” position (two outer pins) on the analog breakout (see Figure 4-10). The analog breakout must be powered from the PD Panel.

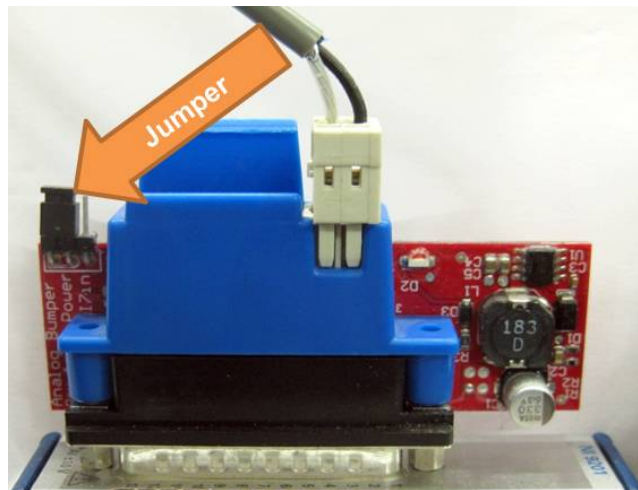

Figure 4-10

These connections enable monitoring of the battery voltage by the Driver Station and the Field Management System.



[R65]

All outputs from sensors, custom circuits and additional electronics shall connect to only the following:

- A. other custom circuits,
- B. additional COTS electronics,
- C. input ports on the Digital Sidecar,
- D. input ports on the Analog Breakout,
- E. the RS-232 DB-9 RS-232 port on the cRIO,
- F. the Ethernet network connected to either Port 1 or Port 2 of the cRIO,
- G. the CAN-bus if and only if all Jaguar speed controllers on the CAN-bus are wired in full compliance with Rules [\[R61\]](#) and [\[R62\]](#), or
- H. the sensor inputs on the Jaguar speed controller.

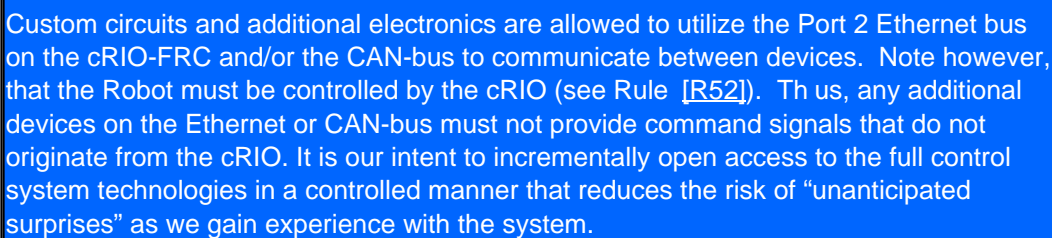

Custom circuits and additional electronics are allowed to utilize the Port 2 Ethernet bus on the cRIO-FRC and/or the CAN-bus to communicate between devices. Note however, that the Robot must be controlled by the cRIO (see Rule [\[R52\]](#)). Thus, any additional devices on the Ethernet or CAN-bus must not provide command signals that do not originate from the cRIO. It is our intent to incrementally open access to the full control system technologies in a controlled manner that reduces the risk of “unanticipated surprises” as we gain experience with the system.

[R66]

A noise filter may be wired across motor leads or PWM leads. For the purposes of Inspection and rules compliance, such filters will not be considered custom circuits, and will not be considered a violation of Rule [\[R49\]](#) or Rule [\[R65\]](#). Acceptable signal filters must be fully insulated and are:

- A one microfarad (1 μ F) or less non-polarized capacitor may be applied across the power leads of any motor on your Robot (as close to the actual motor leads as reasonably possible).
- A resistor may be used as a shunt load for the PWM control signal feeding a servo.

[R67]

Any decorations that involve broadcasting a signal to/from the Robot, such as remote cameras, must be approved by *FIRST* (via e-mail to frcteams@usfirst.org) prior to the event and tested for communications interference at the venue. Such devices, if reviewed and approved, are excluded from Rule [\[R55\]](#).

4.1.10 Pneumatic System

[R68]

To satisfy multiple constraints associated with safety, consistency, Robot Inspection, and constructive innovation, no pneumatic parts other than those explicitly permitted by the Pneumatic System Rules may be used on the Robot.

[R69]

All pneumatic components must be COTS pneumatic devices rated by their manufacturers for working pressure of at least 125psi (with the exception of [\[R71\]-D](#)).

[R70]

All pneumatic components must be used in their original, unaltered condition. Exceptions are as follows:

- A. tubing may be cut,
- B. wiring for pneumatic devices may be modified to interface with the control system,
- C. assembling and connecting pneumatic components using the pre-existing threads, mounting brackets, quick-connect fittings, etc.,
- D. removing the mounting pin from a pneumatic cylinder, provided the cylinder itself is not modified,
- E. labeling applied to indicate device purpose, connectivity, functional performance, etc.

Do not, for example, file, machine, or abrasively remove any part of a pneumatic cylinder – this would cause the part to become a prohibited item. Consider pneumatic components sacred.

[R71]

The only pneumatic system items permitted on 2012 FRC Robots include the items listed below.

- A. Items listed in the *2012 KOP Checklist* or available via *FIRST Choice*.
- B. Pneumatic pressure vent plug valves functionally equivalent to those provided in the KOP.

Parker valves PV609-2 or MV709-2 are recommended.

- C. Solenoid valves with a maximum $\frac{1}{2}$ in. NPT port diameter, and a maximum Cv of 0.32 (if non-KOP valves are used, the team will be required to provide part documentation validating that the valves meet these constraints).
- D. Solenoid valves that are rated for a maximum working pressure that is less than 125 psi rating mandated above are permitted, however if employed, an additional pressure relief valve must be added to the low pressure side of the main regulator. The additional relief valve must be set to a lower pressure than the maximum pressure rating for the solenoid valve.
- E. Additional pneumatic tubing, with a maximum 0.160 in inside diameter, functionally equivalent to that provided in the KOP, with the pressure rating clearly factory-printed on the exterior of the tubing or with supplier documentation showing the pressure rating.
- F. Pressure transducers, pressure gauges, and connecting fittings,
- G. Pressure regulators with a maximum bypass pressure of no more than 60 psi,
- H. Pneumatic cylinders,
- I. Pneumatic storage tanks, and
- J. Compressors compliant with Rule [\[R73\]](#).

For the purposes of the FRC, the following devices are not considered pneumatic devices and are not subject to pneumatic rules (though they must satisfy all other rules):

- a device that creates a vacuum
- closed-loop COTS pneumatic (gas) shocks
- air-filled (pneumatic) wheels

[R72]

If pneumatic components are used on the Robot, the following items are required as part of the pneumatic system and must be connected in accordance with this section.

- A. Pressure gauges to display the “stored” and “working” air pressure (see Rule [\[R74\]](#)),
- B. A pressure relief valve, calibrated and set to release at 125 psi (see Rule [\[R75\]](#)),
- C. A pressure switch, calibrated and connected to the Robot control system (see Rule [\[R76\]](#)),
- D. An easily visible and accessible pressure vent plug valve to manually relieve the stored pressure (see Rule [\[R77\]](#)).

[R73]

Compressed air on the Robot must be provided by one and only one compressor. Compressor specifications may not exceed nominal 12V, 1.05 cfm flow rate, 120 psi maximum working pressure. Off-board compressors must be controlled and powered by the Robot.

If an alternative compressor is used, the team may be required to provide documentation to show compliance with the performance specifications.

The only difference between an on- and off-board compressor is that the off-board compressor is physically removed from the Robot. The intent of this rule is to permit teams to take advantage of the weight savings associated with keeping the compressor off-board. However, using the compressor off-board of the Robot does NOT permit non-compliance with any other applicable rules.

The compressor may be mounted on the Robot, or it may be left off the Robot and used to pre-charge compressed air in the storage tanks prior to bringing the Robot onto the Court.

[R74]

“Working” air pressure on the Robot must be no greater than 60 psi. All working air must be provided through one primary Norgren adjustable pressure regulator.

- A. All “working” pneumatic components (e.g. valves, cylinders, rotary actuators, etc.) must be downstream from this regulator.
- B. Only the compressor, relief valve, pressure switch, pressure vent plug valve, pressure gauge, storage tanks, tubing, and connecting fittings may be in the high-pressure pneumatic circuit upstream from the regulator.
- C. Pressure gauges must be placed in easily visible locations upstream and downstream of the regulator to display the “stored” and “working” pressures.
- D. If the compressor is not included on the Robot (under the provisions of Rule [\[R73\]](#)), the regulator and high-pressure gauge may be located on-board or off-board, provided all other pneumatic rules are satisfied. Note that if the regulator is kept off-board the Robot with the compressor, then only low-pressure (60 psi or less) “working” air can be stored on the Robot.

[R75]

The relief valve must be attached directly to the compressor or attached by suitable brass fittings connected to the compressor output port.

If necessary, teams are required to adjust the relief valve to release air at 125 psi. The valve may or may not have been calibrated prior to being supplied to teams.



[R76]

The pressure switch must be connected to the high-pressure side of the pneumatic circuit (i.e. prior to the pressure regulator) to sense the “stored” pressure of the circuit. The two wires from the pressure switch must be connected directly to a digital input and ground port on the Digital Sidecar, and the cRIO must be programmed to sense the state of the switch and operate the relay module that powers the compressor to prevent over-pressuring the system.

[R77]

The pressure vent plug valve must be connected to the pneumatic circuit such that, when manually operated, it will vent to the atmosphere to relieve all stored pressure. The valve must be placed on the Robot so that it is visible and easily accessible. If the compressor is not used on the Robot, then an additional vent valve must be obtained and connected to the high-pressure portion of the pneumatic circuit off board the Robot with the compressor (see Rule [\[R73\]](#)).

[R78]

The outputs from multiple valves may not be plumbed together into the same input on a pneumatic cylinder.

4.1.11 Operator Console

[R79]

The Operator Console is the collection of the hardware used to run the Driver Station software and any associated equipment, control interfaces, display systems, structure, decorations, etc. used by the Drivers to operate the Robot.

[R80]

The Driver Station software provided on the [Kit of Parts website](#) is the only tool permitted to specify and communicate the operating mode (i.e. Autonomous/Teleop) and operating state (enable/disable) to the Robot. The Driver Station software must be revision 01.07.12.00 or newer.

Teams are permitted to use a portable computing device of their choice (laptop computer, PDAs, etc.) to host the Driver Station software while participating in competition Matches.

Please note that 19V DC, 2 amp power will be provided at the Player Station for Classmates provided in the KOPs via Classmate power adapters. The manufacturer has confirmed that the power supply provided at the Player Station is compatible with both E09 and E11 Classmate versions. No 120 V AC port will be available.

The FMS will verify that the Driver Station software is correct before it will permit a Robot to operate on the Court.

[R81]

Devices hosting the Driver Station software may only interface with the Field Management System (FMS) via the Ethernet cable provided at the Player Station. The Ethernet port on the Operator Console must be easily and quickly accessible.

Teams are strongly encouraged to use pigtailed Ethernet cables on the Ethernet port used to connect to the FMS. Such pigtailed cables will reduce wear and tear on the port and, with proper strain relief employed, will protect the port from accidental jerks.

[R82]

The Operator Console must not exceed 48 in. long by 12 in. deep (excluding any items that are held or worn by the Drivers during the match).

[R83]

The Operator Console must include a graphic display to present the Driver Station diagnostic information. It must be positioned within the Operator Console so that the screen display can be clearly seen during Inspection and during operation in a match.

[R84]

Other than the system provided by the Arena, no other form of wireless communications shall be used to communicate to, from or within the Operator Console.

Examples of prohibited wireless systems include, but are not limited to, active wireless network cards and Bluetooth devices. For the case of FRC, a motion sensing input device (e.g. Microsoft Kinect) is not considered wireless communication and is allowed.

4.2 Revision History

Revision	Release Date	Changes
-	1/3/12	Initial Release

5 The Tournament	3
5.1 Overview	3
5.2 Practice Matches	3
5.2.1 Schedule	3
5.3 Qualification Matches	4
5.3.1 Schedule	4
5.3.2 Match Assignment	4
5.3.3 Qualification Score (QS)	4
5.3.4 Coopertition Score	4
5.3.5 Match Point Exceptions	5
5.3.6 Qualification Seeding	5
5.4 Elimination Matches	5
5.4.1 Alliance Selection Process	5
5.4.2 Backup Teams	6
5.4.3 Elimination Match Ladder	7
5.4.4 Elimination Scoring	7
5.5 Tournament Rules	8
5.5.1 Safety Rules	8
[T01]	8
[T02]	8
5.5.2 Eligibility and Inspection	8
[T03]	8
[T04]	9
[T05]	9
[T06]	9
[T07]	9
[T08]	9
[T09]	9
[T10]	10
[T11]	10
[T12]	10
5.5.3 Referee Interaction Rules	10
[T13]	11
[T14]	11
5.5.4 Yellow and Red Card Rules	11
[T15]	11
[T16]	11
[T17]	11
[T18]	12
[T19]	12

[T20]	12
[T21]	12
5.5.5 Field Reset Rules	12
[T22]	12
[T23]	12
[T24]	12
[T25]	13
5.5.6 Timeout and Backup Team Rules	13
[T26]	13
[T27]	13
[T28]	13
[T29]	13
[T30]	14
[T31]	14
5.5.7 Measurement	14
[T32]	14
5.5.8 Special Equipment Rules	14
[T33]	14
[T34]	14
5.6 Championship Additions	15
5.6.1 Championship Pit Crews	15
5.6.2 Championship Backup Robot	15
5.6.3 5.6.3 FRC Championship Match Ladder	16
5.7 Revision History	16

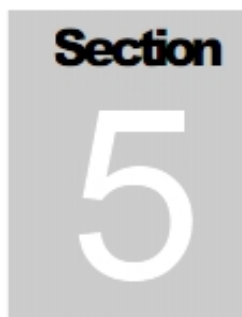

The Tournament

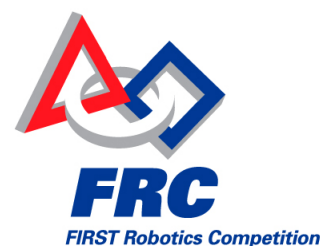

5 The Tournament

5.1 Overview

Each 2012 FRC Regional or Qualifying Event Competition and the 2012 FRC Championship will be played in a tournament format. Each tournament will consist of three sets of Matches called “Practice Matches,” “Qualification Matches,” and “Elimination Matches.” The purpose of the Practice Matches is to provide each team a chance to run its Robot on the playing field prior to the start of the competition Matches. The purpose of the Qualification Matches is to allow each team to earn a seeding position that may qualify them for participation in the Elimination Matches. The purpose of the Elimination Matches is to determine the event Champions.

5.2 Practice Matches

5.2.1 Schedule

The Practice Matches will be played on the first day of each competition. The Practice Match schedule will be available as soon as possible before Practice Matches start. Practice Matches will be randomly assigned with each team being assigned an equal number of Matches. At some events, additional Matches may be available on a standby basis. Each Practice Match will be conducted as a “competition Match” with approximately two minutes for set up, two minutes and fifteen seconds of regular game play (including operations), and one minute to clear the

field.

5.3 Qualification Matches

5.3.1 Schedule

The Qualification Matches will consist of a series of Matches, with an Arena reset between each Match. The Qualification Match schedule will be available as soon as possible, but no later than 1 hour before Qualification Matches are scheduled to begin.

5.3.2 Match Assignment

The Field Management System (FMS) will assign each team two Alliance partners for each Qualification Match played using a predefined algorithm.

All teams will play the same number of Qualification Matches except if the number of team appearances (number of teams multiplied by number of Matches) is not divisible by six; in that case the FMS will randomly select some teams to play an extra Match. For purposes of seeding calculations, those teams will be designated as Surrogates for the extra Match. If teams play a Match as a Surrogate, it will be indicated on the Match schedule, and it will always be their third Match.

5.3.3 Qualification Score (QS)

Qualification Points are awarded to each team at the completion of each Qualification Match and are dependant on the final score:

- Each team on the winning Alliance will receive two (2) Qualification Points.
- Each team on the losing Alliance will receive zero (0) Qualification Points.
- In the event of a tied score, all six teams will receive one (1) Qualification Point.
- Additional Qualification Points will be awarded to each team on an Alliance equal to any Coopertition Points earned.

The total number of Qualification Points earned by a team throughout their Qualification Matches will be their Qualification Score.

5.3.4 Coopertition Score

The total number of Coopertition Points earned by a team throughout their Qualification Matches will be their Coopertition Score.

5.3.5 Match Point Exceptions

A Surrogate receives zero Qualification Points.

A team is declared a no-show if no member of the team is in the Alliance Station at the start of the Match; a no-show team will be disqualified from that Match.

During the Qualification Matches, teams can be individually disqualified in a Match. A disqualified team will receive zero Qualification Points.

5.3.6 Qualification Seeding

All teams in attendance will be seeded during the Qualification Matches. If the number of teams in attendance is 'n', they will be seeded '1' through 'n', with '1' being the highest seeded team and 'n' being the lowest seeded team.

The FMS will rank all teams in decreasing order, using the following sorting criteria:

1 st order sort	Qualification Score	
2 nd order sort	Cumulative sum of Hybrid Hoop points	
3 rd order sort	Cumulative sum of Bridge points	
4 th order sort	Cumulative sum of Teleop Hoop points	
5 th order sort	Random sorting by the FMS	

5.4 Elimination Matches

At the end of the Qualification Matches, the top eight seeded teams will become the Alliance Leads. The top seeded Alliances will be designated, in order, Alliance One, Alliance Two, etc., down to Alliance Eight. Using the Alliance selection process described below, each team will choose two other teams to join their Alliance.

5.4.1 Alliance Selection Process

Each team will choose a student team Representative who will proceed to the Arena at the designated time (typically before the lunch break on the final day of the Competition) to represent their team. The team Representative for each Alliance Lead is called the Alliance Captain.

The Alliance selection process will consist of two rounds during which each Alliance Captain will invite a team

seeded below them in the standings to join their Alliance. The invited team must not already have declined an invitation.

Round 1: In descending order (Alliance One to Alliance Eight) each Alliance Captain will invite a single team. The invited team Representative will step forward and either accept or decline the invitation.

If the team accepts, it is moved into that Alliance.

- If an invitation from a top eight Alliance to another Alliance Lead is accepted, all lower Alliance Leads are promoted one spot and the next highest seeded unselected team will move up to become Alliance Eight.

If the team declines, that team is not eligible to be picked again and the Alliance Captain extends another invitation to a different team.

- If an invitation from a top eight Alliance to another Alliance Lead is declined, the declining team may still invite teams to join their Alliance, however, it cannot accept invitations from other Alliances.

The process continues until Alliance Eight makes a successful invitation.

Round 2: The same method is used for each Alliance Captain's second choice except the selection order is reversed, with Alliance Eight picking first and Alliance One picking last. This process will lead to eight Alliances of three teams.

5.4.2 Backup Teams

Of the remaining eligible teams, the highest seeded teams (up to eight) shall remain on standby and be ready to play as a Backup team. If a Robot from any team in an Elimination Match becomes inoperable the Alliance Captain may have the highest seeded Backup team join the Alliance. The resulting Alliance would then be composed of four teams, but only three teams will be permitted to continue with tournament play. The replaced team remains part of the Alliance for awards but cannot play, even if their Robot is repaired.

The original three-team Alliance shall only have one opportunity to draw from the Backup teams. If a second Robot from the Alliance becomes inoperable, then the Alliance must play the following Matches with only two (or even one) Robots. It is in the best interest of all teams to construct their Robots to be as robust as possible to prevent this situation.

- Example: Three teams, A, B and C, form an Alliance going into the Elimination Matches. The highest seeded team not on one of the eight Alliances is team D. During one of the Elimination Matches, team C's Robot becomes inoperable. The Alliance Captain decides to bring up team D to replace team C. team C and their Robot may not play in any subsequent Elimination Matches.

In the case where a Backup team is called up to the winning Alliance, there will be a four-team Champion Alliance.

5.4.3 Elimination Match Ladder

The Elimination Matches will take place on the afternoon following completion of the Qualification Matches. Elimination Matches are played in a ladder format as follows:

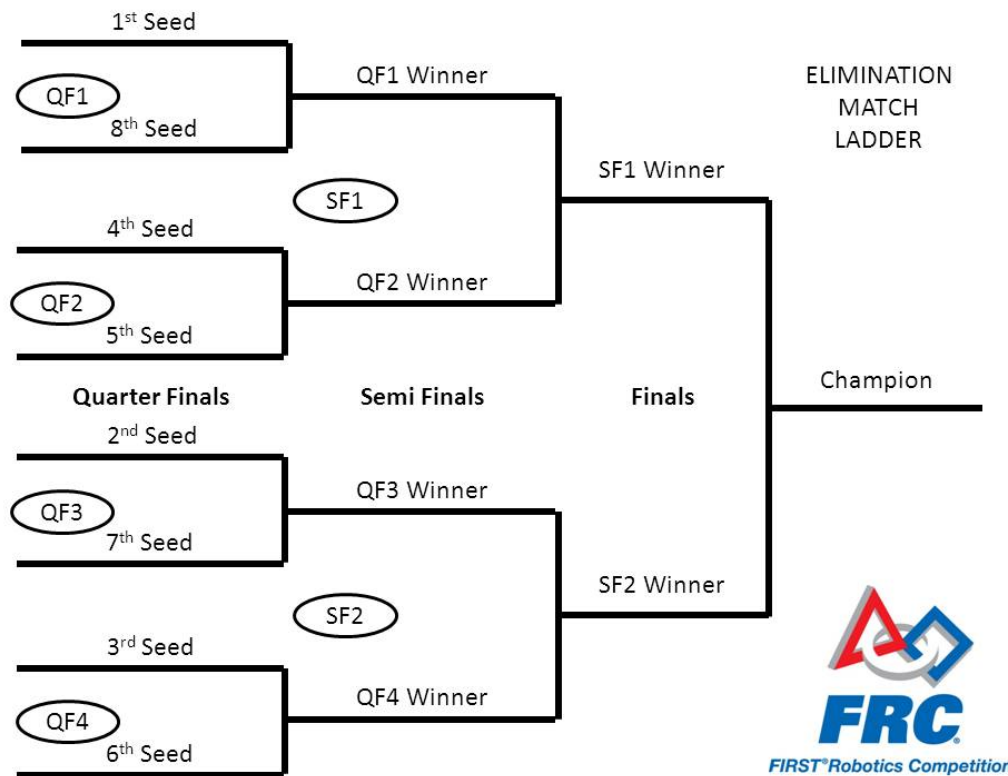

In order to allow equal time between Matches for all Alliances, the order of play will be:

- QF1-1, QF2-1, QF3-1, QF4-1,
- Then QF1-2, QF2-2, QF3-2, QF4-2,
- Then QF1-3*, QF2-3*, QF3-3*, QF4-3*
- Then any QF replays due to ties*
- Then SF1-1, SF2-1, SF1-2, SF2-2, SF1-3*, SF2-3*
- Then any SF replays due to ties*
- Then F-1, F-2, F-3*
- Then any F replays due to ties*

(* - if required)

5.4.4 Elimination Scoring

In the Elimination Matches teams do not earn Qualification Points; they earn a win, loss or tie. Within each bracket of the Elimination Match ladder, the first Alliance to win two Matches will advance.

In the case where the Match score of each Alliance is equal, the tie will be broken by awarding an extra point to the Alliance with the highest number of Foul points granted (the Alliance that played the cleaner Match). If both Alliances have the same number of Foul points, the extra point will be awarded to the Alliance with the highest Hybrid points. If both Alliances have the same Hybrid score, the extra point will be awarded to the Alliance with the most Bridge points. If both Alliances scored the same number of Bridge points, the match is considered truly tied and will be replayed if needed.

5.5 Tournament Rules

5.5.1 Safety Rules

[T01]

All competition attendees must wear safety glasses while in the Arena.

[T02]

Radio control mode of Robot operation is not permitted in areas anywhere outside the Arena or practice field. Robots must only be operated by tether when not within the Arena or practice field.

5.5.2 Eligibility and Inspection

[T03]

A team will only be allowed to participate in a Match and receive Qualification Points only if it has passed Inspection. If it is learned after the start of the Match that a team did not pass Inspection, the team's entire Alliance will receive a Red Card for that Match.

Please take note of this rule. It is important that FRC teams make sure their Alliance partners have passed Inspection. Allowing a partner that has not passed Inspection to play with you puts you at risk of disqualification. We recommend that you check

check with your Alliance partners early and help them to pass Inspection before your compete together.

[T04]

At each event, the Lead Robot Inspector (LRI) has final decision on the legality of any part or mechanism.

[T05]

Any Robot construction technique or element that is not in compliance with the Robot Rules must be rectified before a Robot will be allowed to compete or continue competing. Robots must fully pass Inspection before they will be allowed to compete in Qualification Matches.

[T06]

At the time of Inspection, the Robot must be presented with all Mechanisms (including all Components of each Mechanism), configurations, and decorations that will be used on the Robot during the entire competition event. It is acceptable, however, for a Robot to play Matches with a subset of the Mechanisms that were present during Inspection. Only Mechanisms that were present during the Inspection may be added, removed or reconfigured between Matches. If Mechanisms are changed between Matches, the reconfigured Robot must still meet all Inspection criteria.

[T07]

Robots will normally be allowed to participate in scheduled Practice Matches prior to passing Inspection. However, the FTA, LRI and/or Head Referee may determine at any time that the Robot is unsafe, and may prohibit further participation in Practice Matches until the condition is corrected and the Robot passes Inspection.

[T08]

If a Robot is rejected by Inspectors due to a safety issue or concern related to the Robot's method of storing energy (see Rule [\[R01\]](#)), the concerned items must be disabled or removed from the Robot before it can compete in a Match. The team bears the burden of proof that such a rejection is not valid. Teams should be prepared to provide justifiable test data or calculations during Inspection to support their design.

[T09]

The Robot Bill of Materials (BOM) must be presented at the time of Inspection.

Teams are encouraged to use the BOM Template posted on the FIRST website. Please note that while BOMs must be shown to Inspectors, FRC teams are not required to submit their BOMs to the Inspectors.

[T10]

If a Robot is modified after it has passed Inspection, other than modifications described in [\[T06\]](#), that Robot must be re-Inspected.

If an observation is made that another team's Robot may be in violation of the Robot rules, please approach FIRST officials to review the matter in question. This is an area where Gracious Professionalism is very important.

[T11]

FIRST Officials may re-inspect Robots participating in competition Matches to ensure compliance with the rules.

[T12]

For the safety of all those involved, Inspections must take place with the Robot powered off, pneumatics unpressurized, and springs or other stored energy devices in their lowest potential energy states (i.e. battery removed). Power and air pressure should only be enabled on the Robot during those portions of the Inspection process where it is absolutely required to validate certain system functionality and compliance with specific rules (firmware check, etc). Inspectors may allow the Robot to be powered up beyond the parameters above if both criteria below are met.

- A. The Robot design requires power or a charged stored energy device in order to confirm that the Robot meets volume requirements, and
- B. the team has included safety interlocks that prevent unexpected release of such stored energy.

5.5.3 Referee Interaction Rules

[T13]

The Head Referee has the ultimate authority in the Arena during the competition, but may receive input from additional sources, particularly Game Design Committee members, *FIRST* personnel, and technical staff that may be present at the event. The Head Referee rulings are final. The Referee will not review recorded replays under any circumstances.

[T14]

If a team needs clarification on a ruling or score, a pre-college student from that team should address the Head Referee after a field reset has been signaled. A team signals their desire to speak with the Head Referee by standing in the red or blue Question Box which will be placed on the floor at each end of the scoring table. Depending on timing, the Head Referee may postpone any requested discussion until the end of the subsequent Match.

5.5.4 Yellow and Red Card Rules

[T15]

The Head Referee may assign a Yellow Card as a warning of egregious Robot or team member behavior at the Arena. A Yellow Card will be indicated by the Head Referee standing in front of the team's Player Station and holding a yellow card in the air after the completion of the Match. In the first Match that a team receives a Yellow Card, it acts as a warning.

Once a team receives a Yellow Card, its team number will be colored yellow on the audience screen at the beginning of all subsequent Matches as a reminder to the team, the Referees, and the audience that they have been issued a Yellow Card.

[T16]

A team will be issued a Red Card (disqualification) in any subsequent Match that they receive an additional Yellow Card. This will occur after the completion of the Match. A Red Card will be indicated by the Head Referee standing in front of the team's Player Station and holding a yellow card and red card in the air simultaneously. The team will still carry their Yellow Card into subsequent Matches.

[T17]

If the behavior is particularly egregious, a Red Card may be issued without being preceded by a Yellow Card, at the Head Referee's discretion. The team will still carry a Yellow Card into subsequent Matches.

[T18]

Yellow Cards do not carry forward between Qualification Matches and Elimination Matches. All teams move into the Elimination Matches with a clean slate.

[T19]

If an team is disqualified during a Match for a reason other than receiving an additional Yellow Card, they will receive a Red Card. This will occur after the completion of a Match and will be indicated by the Head Referee standing in front of the team's Player Station and holding a red card in the air.

[T20]

During the Qualification Matches, a team that receives a Red Card will receive zero Qualification Points. The rest of the teams in their Alliance will still receive the earned Qualification Points.

[T21]

During the Elimination Matches, a team receiving a Red Card will cause the disqualification of their entire Alliance for that Match.

5.5.5 Field Reset Rules

[T22]

At the conclusion of a Match, all players shall remain in their assigned locations until the Head Referee issues the "field-reset" signal. Once the Head Referee issues this signal, the "Match-reset" period will begin. The Arena must be cleared of Robots and Operator Consoles from the Match just ended, and the Robots and Operator Consoles for the following Match must be placed in position and ready to start before the expiration of the "Match-reset" period. Field Attendants will reset the Arena elements during this time.

[T23]

Robots will not be re-enabled after the conclusion of the Match, nor will teams be permitted to tether to the Robot.

[T24]

The Qualification Match schedule will indicate Alliance partners and Match pairings. It will also indicate the Alliance color assignment, “red” or “blue,” for each Match.

[T25]

If, in the judgment of the Head Referee, an “Arena fault” occurs that affects either the play or the outcome of the Match, the Match will be replayed. Example Arena faults include broken Arena elements, power failure to a portion of the Arena, improper activation of the Arena control system, errors by Arena personnel, etc.

5.5.6 Timeout and Backup Team Rules

[T26]

There are no time-outs in the Qualification Matches. If a Robot cannot report for a Match, the queuing manager must be informed and at least one member of the team should report to the Arena for the Match to avoid receiving a Red Card.

[T27]

During the Elimination Matches, if circumstances require an Alliance to play in back-to-back Matches, they will be granted an additional minute of set-up time to reset and allow their Robots to cool down.

[T28]

In the Elimination Matches, each Alliance will be allotted one Timeout of up to 6 minutes. If an Alliance wishes to call for a Timeout, they must submit their Timeout coupon to the Head Referee within two minutes of the Head Referee issuing the arena reset signal preceding their Match. When this occurs, the Time-out Clock will count down the six minutes starting with the expiration of the Arena reset period. Both Alliances will enjoy the complete 6-minute window. In the interest of tournament schedule, if an Alliance completes their repairs before the Time-out Clock expires, the Alliance Captain is encouraged to inform the Head Referee that they are ready to play and remit any time remaining in the Timeout. If Alliances are ready before the 6-minute window, the next Match will start. There are no cascading Timeouts. An Alliance may not offer their unused Timeout to their opponent.

[T29]

If during a Timeout an Alliance Captain determines that they need to call up a Backup Robot, they must submit their Backup Robot coupon to the Head Referee while there is still at least two minutes remaining on the Time-out

Clock. After that point, they will not be allowed to utilize the Backup Robot. Alternatively, an Alliance Captain may choose to call up a Backup Robot without using their Timeout by informing the Head Referee directly within two minutes of the Head Referee issuing the Field Reset Signal preceding their Match.

[T30]

In the case where the Alliance Captain's Robot is replaced with the Backup Robot, the Alliance Captain is allowed in the Alliance Station as a thirteenth Alliance member so they can serve in an advisory role to their Alliance.

[T31]

In any case where a Head Referee has to stop an Elimination Match (e.g. due to Arena fault or a safety issue), it will be replayed immediately. Alliances do not have the option to request either a Timeout or Backup team. The sole exception is if the replay is due to an Arena fault that rendered a Robot inoperable.

If an Elimination Match is replayed per [T30] the Head Referee has the option of calling a Timeout without charging any FRC team with a Timeout.

5.5.7 Measurement

[T32]

Team members may not measure any component or dimension of the playing field during FRC events. Measurements are permitted on the practice field, if available (move to special equipment once ironed out)

5.5.8 Special Equipment Rules

[T33]

The only equipment that may be brought in to the Alliance Station is the Operator Console and non-powered signaling devices. Reasonable decorative items, and special clothing and/or equipment required due to a disability may be brought into the Alliance or Kinect Stations. Other items, particularly those intended to provide a competitive advantage for the team, are prohibited.

[T34]

Devices used solely for the purpose of planning or tracking strategy of game play are allowed inside the Alliance Station, if they meet all of the following conditions:

- Do not connect or attach to the Operator Console
- Do not connect or attach to the Court or Arena
- Do not connect or attach to another Alliance member
- Do not communicate with anything or anyone outside of the Arena.
- Do not include any form of enabled wireless electronic communication (e.g. radios, walkie-talkies, cell phones, Bluetooth communications, WiFi, etc.)
- Do not in any way affect the outcome of a Match, other than by allowing Players to plan or track strategy for the purposes of communication of that strategy to other Alliance members.

5.6 Championship Additions

For the 2012 FRC Championship, teams will be split into four divisions. Each division will play exactly like a Regional Event and produce the Division Champions. Those four Alliances will then proceed to the Championship Playoffs to determine the 2012 FRC Champions.

Procedures in [Sections 5.1-5.5](#) apply during the Championship, with the following additions:

5.6.1 Championship Pit Crews

During the Elimination Matches, extra team members are often needed to move the team Robot from the team's pit area to the queuing area and into the Arena. For this reason, each team is permitted to have three (3) additional "pit crew" members who can also help with needed Robot repairs/maintenance. We suggest that all teams assume they may be chosen for an Alliance and think about the logistics of badge distribution and set a plan prior to the pairings. It is each Alliance Captain's responsibility to get the team's badges to the team pit crew members.

Only team members wearing proper badges are allowed on the Arena floor. *FIRST* will distribute these badges to the Alliance Captains during the Alliance Captain meeting, which takes place on the division fields. These badges will provide the necessary access to the Arena for pit crew members.

5.6.2 Championship Backup Robot

If an Alliance has not previously brought in a Backup Robot, and a Robot becomes disabled during the Championship Playoffs and can not continue, the Alliance may request a Backup Robot. The Alliance Captain will be presented the option of having one of the three Division Finalist Robots, chosen randomly, from their division join the Alliance as a Backup Robot.

If an Alliance has won their division with a Backup Robot and moved on to the FRC Championship Playoffs, the Backup Robot continues to play for the Alliance in the Championship Playoffs.

As noted in [Section 5.4.2](#), the original three-Robot Alliance shall only have one opportunity to draw from the Backup Robots. If the Alliance has brought in a Backup Robot during the division Elimination Matches or the Championship Playoffs, they cannot bring in a second Backup Robot. If a second Robot from the Alliance becomes inoperable during the Championship Playoffs, then the Alliance must play the following Matches with only two (or even one) Robots.

In either case, the replaced Robot remains part of the Alliance for awards but can not rejoin tournament play, even if their Robot is repaired. If the Alliance wins the Championship Playoffs, the FRC Champions will be all three original members of the Division Champion Alliance and the Backup Robot.

5.6.3 5.6.3 FRC Championship Match Ladder

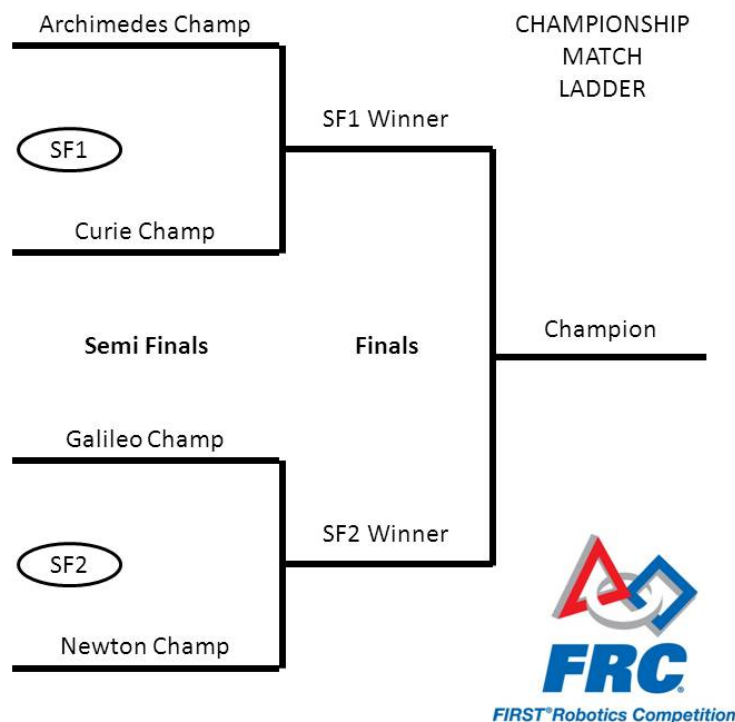

The FRC Championship Matches will play exactly like the Semi-Finals and Finals of the Elimination Matches.

5.7 Revision History

Revision	Release Date	Changes
-	1/3/12	Initial Release